

## Video inserter

### RL1-MIB2-E

**Compatible with  
VW / SEAT / SKODA vehicles  
with MIB2 Entry infotainment and 5inch monitor**



**Video-inserter with 2 video inputs and 1 rear-view camera input**

#### Product features

- Video-inserter for factory-infotainment systems
- 1 CVBS rear-view camera video-input
- 2 CVBS video-inputs for after-market devices (e.g. USB-Player, DVB-T2 tuner, ...)
- Automatic switching to rear-view camera input on engagement of the reverse gear
- Video-in-motion (ONLY for connected video-sources)
- Video-inputs NTSC compatible

## Contents

### 1. Prior to installation

- 1.1. Delivery contents
- 1.2. Checking the compatibility of vehicle and accessories
- 1.3. Connectors – video interface
- 1.4. Dip-switch settings
  - 1.4.1. Enabling the interface's video inputs (dip 2-3)
  - 1.4.2. Rear-view camera setting (dip 5)

### 2. Installation

- 2.1. Place of installation
  - 2.1.1. Place of Installation – video interface
  - 2.1.2. Place of Installation – daughter PCB
- 2.2. Connection schema
- 2.3. Connecting video-interface – Power
- 2.4. Opening the factory monitor (not Skoda vehicles)
- 2.5. Connection of the 50pin ribbon cables
  - 2.5.1. Warning notes, concerning the installation of ribbon cables
- 2.6. Closing the monitor's rear-side.
- 2.7. Assembly - head unit, monitor and daughter PCB
- 2.8. Connection – picture signal cable
- 2.9. Installation – Skoda vehicles
  - 2.9.1. Skoda monitor – removal and opening
  - 2.9.2. Skoda monitor mainboard – disconnection and removal
  - 2.9.3. Connection of the 50pin ribbon cables – Skoda
  - 2.9.4. Reassembling – Skoda head unit and monitor
- 2.10. Connection – video sources
- 2.11. After-market rear-view camera
- 2.12. Audio insertion
- 2.13. Connection – video interface and external keypad
- 2.14. Picture settings

### 3. Video interface operation

### 4. Specifications

### 5. FAQ – Trouble Shooting-Interface function

### 6. Technical support

## Legal Information

By law, watching moving pictures while driving is prohibited, the driver must not be distracted. We do not accept any liability for material damage or personal injury resulting, directly or indirectly, from installation or operation of this product. Apart from using this product in an unmoved vehicle, it should only be used to display fixed menus or rear-view-camera video when the vehicle is moving (for example the MP3 menu for DVD upgrades).

Changes/updates of the vehicle's software can cause malfunctions of the interface. Up to one year after purchase we offer free software-updates for our interfaces. To receive a free update, the interface has to be sent in at own cost. Wages for de-and reinstallation and other expenditures involved with the software-updates will not be refunded.

No liability for vehicle wire colours and pin definition!

Changes by the vehicle manufacturer are possible. The given information has to be verified by the installer.

## 1. Prior to installation

Read the manual prior to installation. Technical knowledge is necessary for installation. The place of installation must be free of moisture and away from heat sources.

### 1.1. Delivery contents



## 1.2. Checking the compatibility of vehicle and accessories

### Requirements

Brand	Compatible vehicles	Infotainment
<b>Seat</b>	Ibiza (6P) model years 2016 – 05/2017 Leon3 (5F) model year 2013-2017 Toledo4 (KG) model year 2016-2017	MIB2 Entry - Media System Touch Color – All-in-One DIN head-unit with 5inch color monitor and SD-Slot without CD-drive
<b>Skoda</b>	Fabia3 (NJ) model years 10/2014-05/2017 Octavia3 (5E) model years 2012-2017 Rapid (NH1) model years 2016-2017 Superb3 (3V) model years 2015-2017 Yeti (5L) model years 2015-2016	MIB2 Entry - Radio Swing - All-in-One DIN head-unit with 5inch color monitor and SD-Slot without CD-drive
<b>VW</b>	Beetle (5C) model years since 2015- Caddy4 (SA) model years 2016-2020 Golf7 Sportsvan model years 2014-2017 Polo5 (6C) model years 2014-2017 Scirocco3 (13) model years 2016-2018 Sharan (7N) model years since 2016 Touran (5T) model years 2016-2017 Transporter T6 (SG) 07/2015-10/2019	MIB2 Entry - Composition Color (LG HU)- All-in-One DIN head-unit with CD-drive above 5inch monitor or without CD-drive

### Limitations

#### *Video only*

The interface inserts ONLY video signals into the infotainment. For inserting Audio signals either the possibly existing factory audio-AUX-input or a FM-modulator can be used. If 2 audio sources shall be connected to the infotainment, an additional electronic is necessary to switch them.

#### *Factory rear-view camera*

Automatically switching-back from inserted video to factory rear-view camera is only possible while the reverse gear is engaged. To delay the switch-back an additional electronic part is required.

#### *Video input signal*

Only NTSC compatible.

## 1.3. Boxes and connectors

### 1.3.1. Video Interface

The video-interface converts the video signals of connected after-market sources in a factory monitor compatible picture signal which is inserted in the factory monitor, by using separate trigger options. Further it reads the vehicle's digital signals out of the vehicle's CAN-bus and converts them for the video interface.

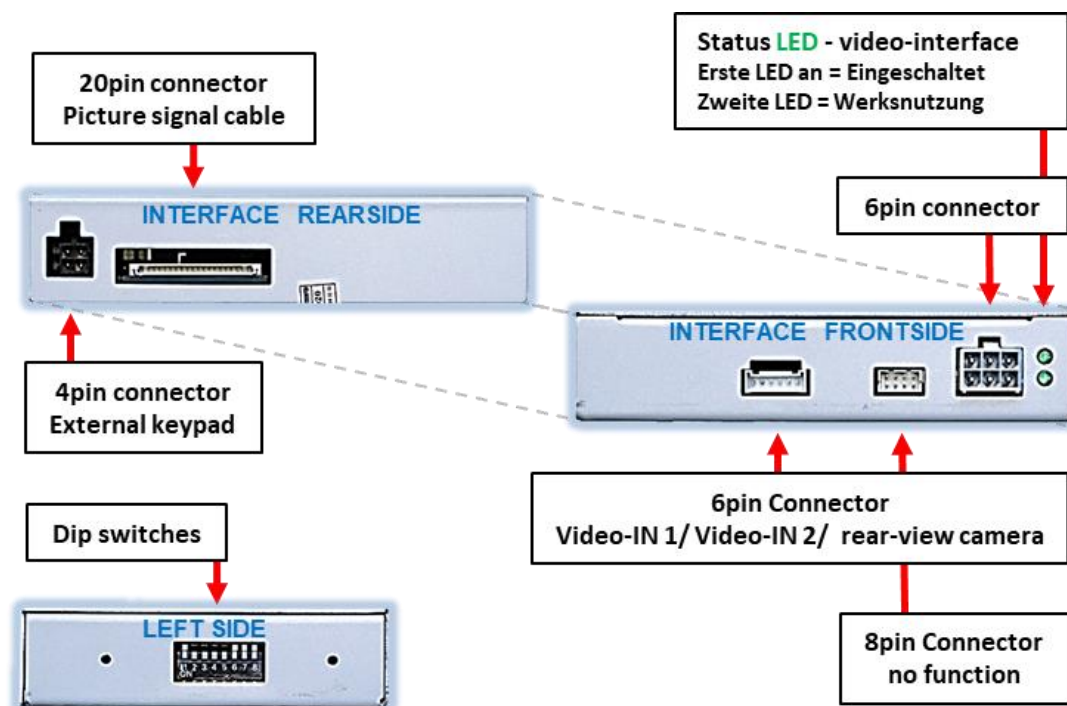

## 1.3.2. Dip-switch settings

Some settings have to be selected by the dip-switches on the video interface. Dip position down is ON and position up is OFF.

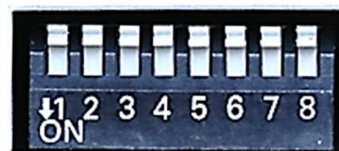

Dip	Function	ON (down)	OFF (up)
1	No function		set to OFF
2	CVBS AV1-input	enabled	disabled
3	CVBS AV2-input	enabled	disabled
4	No function		set to OFF
5	Rear-view cam type	after-market	factory or none
6	No function	Set to OFF	
7			
8			

**After each Dip-switch-change a power-reset of the Can-box has to be performed!**

See the following chapters for detailed information.

### 1.3.2.1. Enabling the interface's video inputs (dip 2-3)

Only the enabled video inputs can be accessed by switching through the interface's video sources. It is recommended to enable only the required inputs, because the disabled inputs will be skipped while switching through the video interfaces inputs.

### 1.3.2.2. Rear-view camera setting (dip 5)

If set to OFF, the interface switches to factory LVDS picture while the reverse gear is engaged to display factory rear-view camera or factory optical park system picture.

If set to ON, the interface switches to its rear-view camera input while the reverse gear is engaged.

**Note:** Dips 1, 4, 6, 7 and 8 are out of function and have to be set to **OFF**.

## 2. Installation

To install the interface, first switch off the ignition and disconnect the vehicle's battery. Please read the owner's manual of the car, regarding the battery's disconnection! If required, enable the car's Sleep-mode (hibernation mode)

In case the sleep-mode does not succeed, the disconnection of the battery can be done with a resistor lead.

If the necessary stabilized power supply for the interface is not taken directly from the battery, the chosen connection has to be checked for being constantly stable.

The interface needs a permanent 12V source!

### 2.1. Place of installation

#### 2.1.1. Place of installation - interface-box

The interface is prepared to be connected behind the vehicle's monitor and head-unit.

#### 2.1.2. Place of installation - daughter PCB

The interface's daughter PCB is prepared to be installed inside or outside the monitor housing depending on the head unit.

#### External PCB installation

Head-Unit with  
bottom-mounted DIN housing

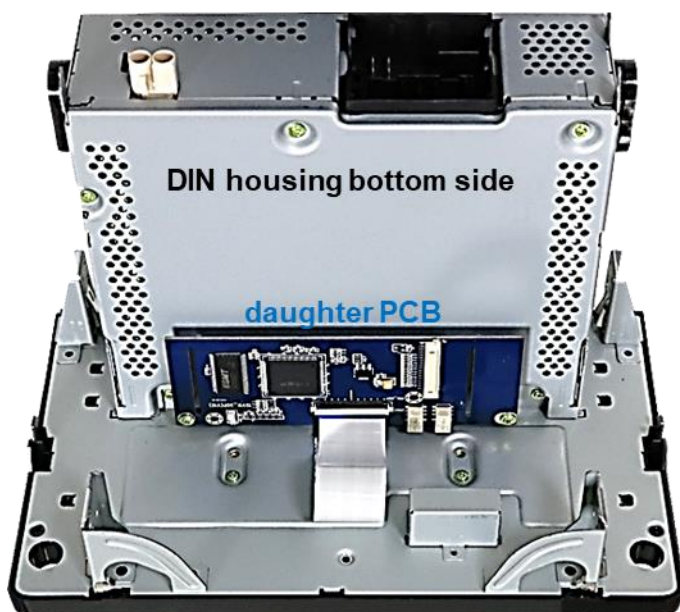

#### Internal PCB installation

e.g. Skoda

Head-Unit with  
bottom-mounted DIN housing

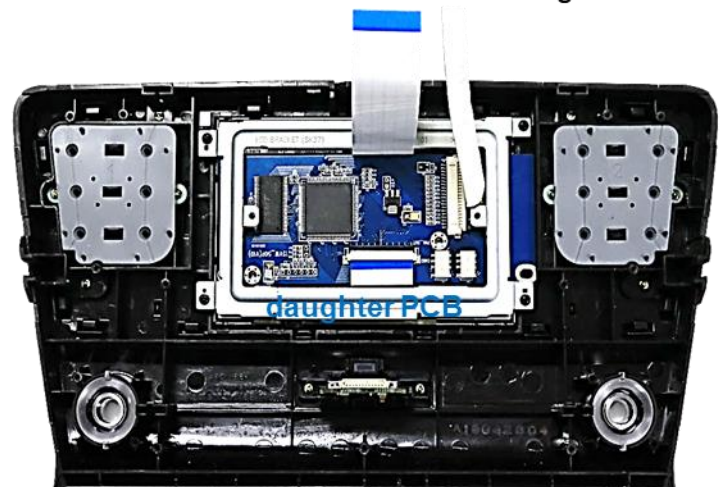

## 2.2. Connection schema

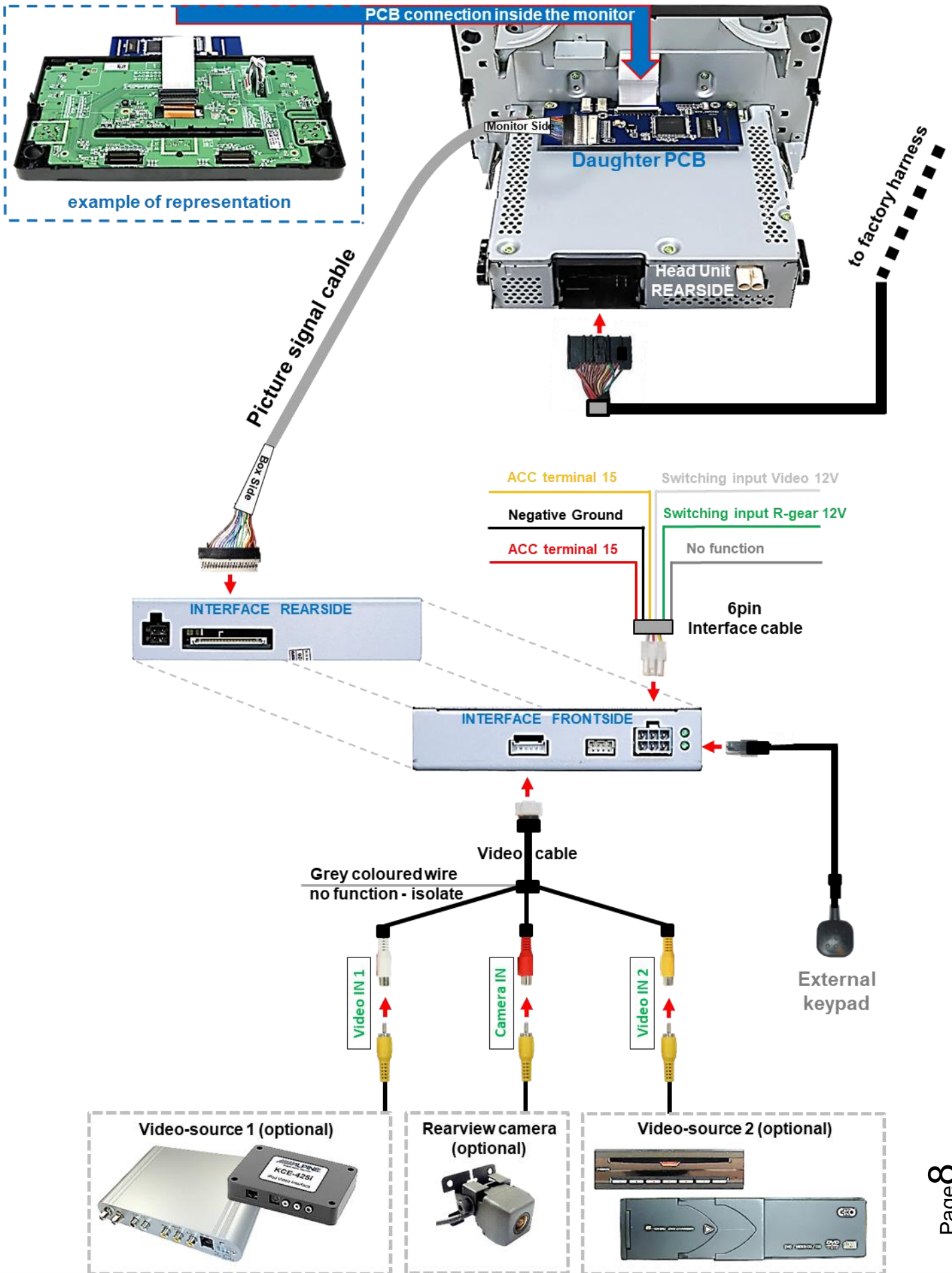



## 2.3. Connecting video-interface – Power

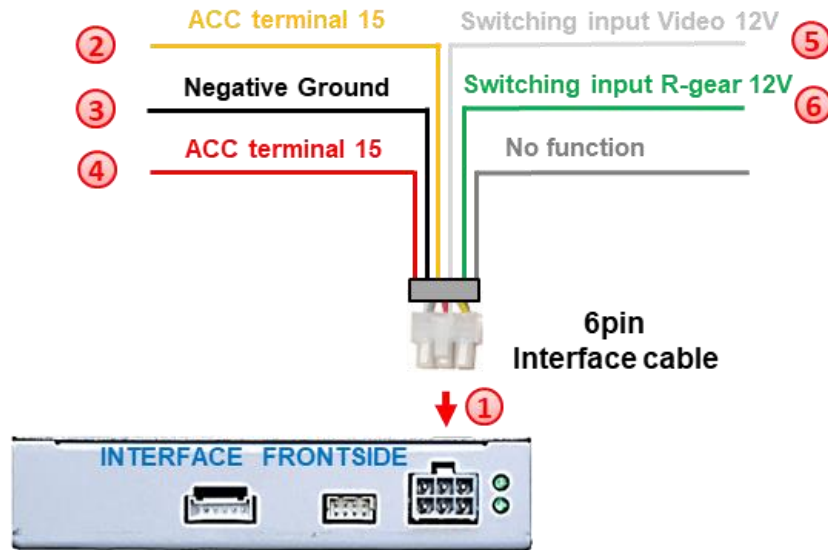

- ① Connect the white female 6pin connector of the 6pin interface cable to the male 6pin connector of the video interface.
- ② Connect the yellow wire of the 6pin interface cable to +12V ACC terminal 15.
- ③ Connect the black wire of the 6pin interface cable to the vehicle's negative Ground.
- ④ Connect the red wire of the 6pin interface cable to 12V ACC terminal 15.
- ⑤ The white wire of the 6pin interface cable switches the video sources by a 12V impulse for 2-3 seconds as an alternative to the external keypad.
- ⑥ Connect the green switching input wire of the 6-pin interface cable to the reversing light, according to the connection diagram in the section "After-Market rear view camera".

**Note:** The connection of the green wire (Reverse signal) will be described in chapter "After-market rear-view camera". The white wire will be used to switch the enabled video sources (see chapter "video interface – operation").

The possibly existing grey wire is out of function and has to be isolated.

*Exceptionally, the power supply to the video interfaces may not be interrupted after switching to the vehicle's sleep mode. If the interface LEDs continue to shine even in the vehicle's sleep mode, please contact the support!*

## 2.4. Opening the factory monitor (not Skoda vehicles)

Remove the vehicle's head-unit.



- 1 Turn out both screws at the **outer** side of the top part of the head unit (red arrows) and both screws at the bottom part of the head unit (red arrows). Remove the head unit from the monitor and lay it aside.

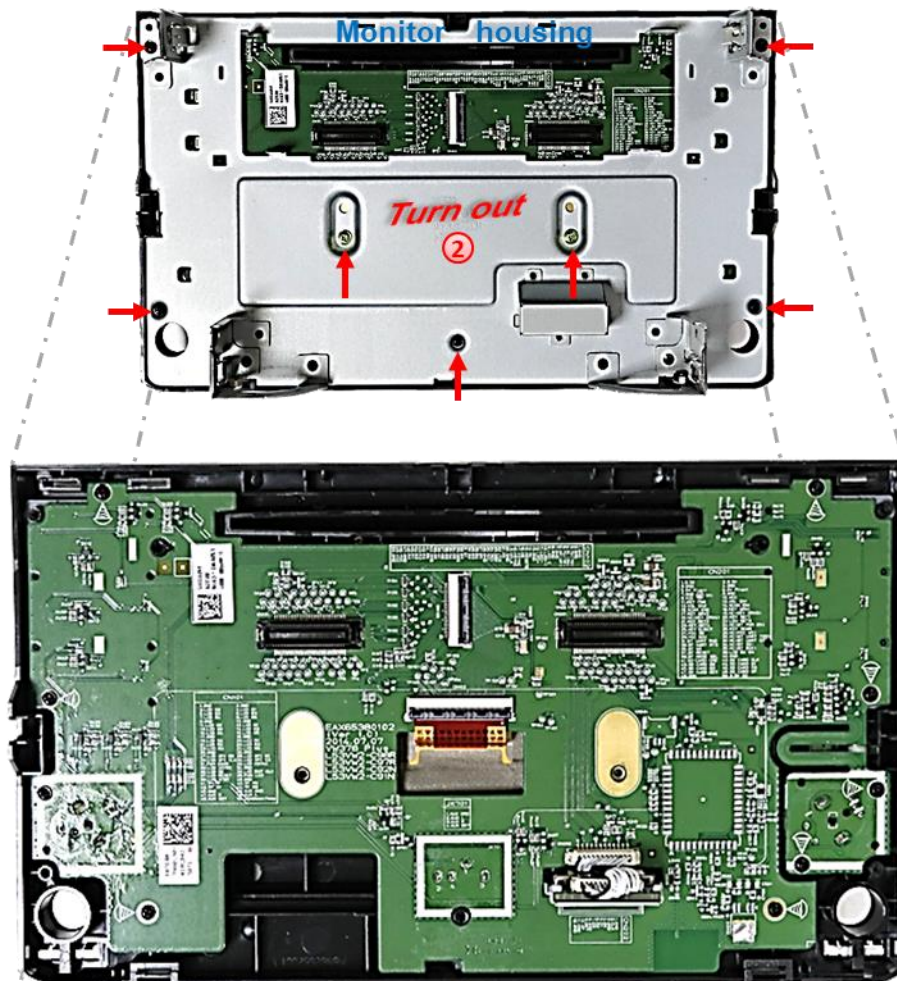

- 2 Turn out the 7 screws (red arrows) at the rear side of the monitor and remove the metal sheet to set free the mainboard's ribbon cable base with the factory picture signal cable.

## 2.5. Connection of the 50pin ribbon cables

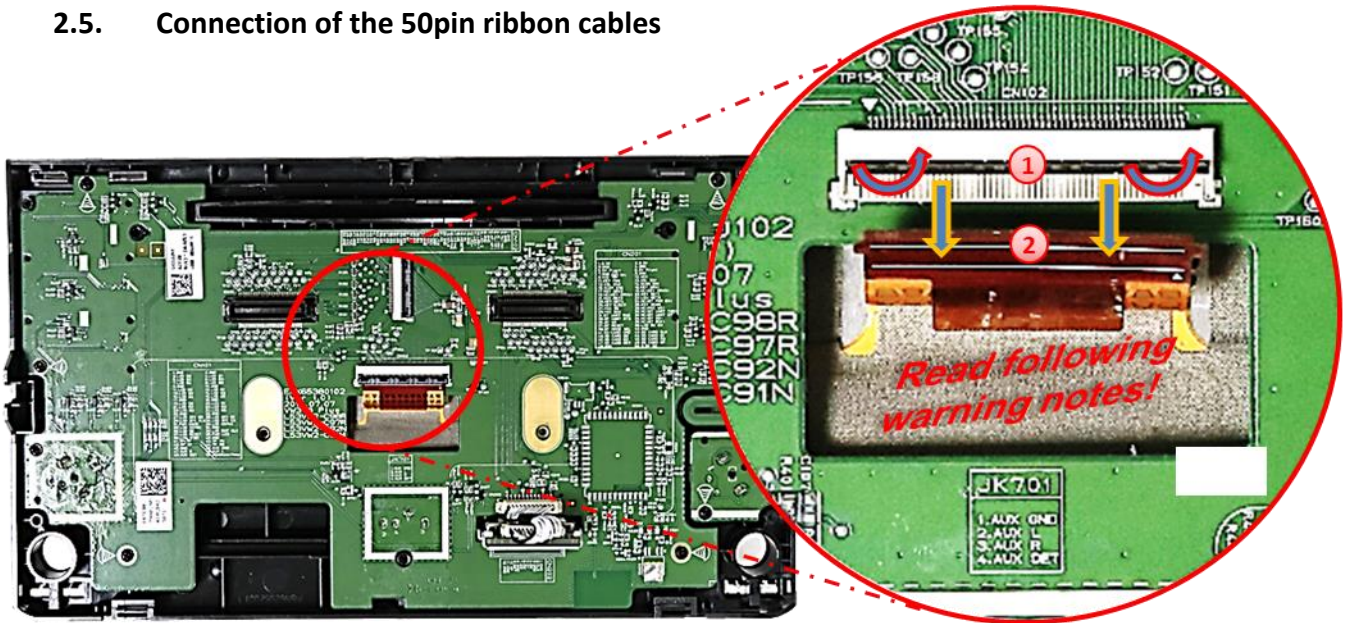

- 1 Fold upwards the black hinge of the factory ribbon cable base to unlock the original brown colored 50pin ribbon cable of the factory PCB.
- 2 Carefully pull out the original 50pin ribbon cable in arrow direction.

**Note: The original short ribbon cable is made by stiff material. To avoid any breakage it mustn't be folded back to much, either while the installation nor with the final assembly.**

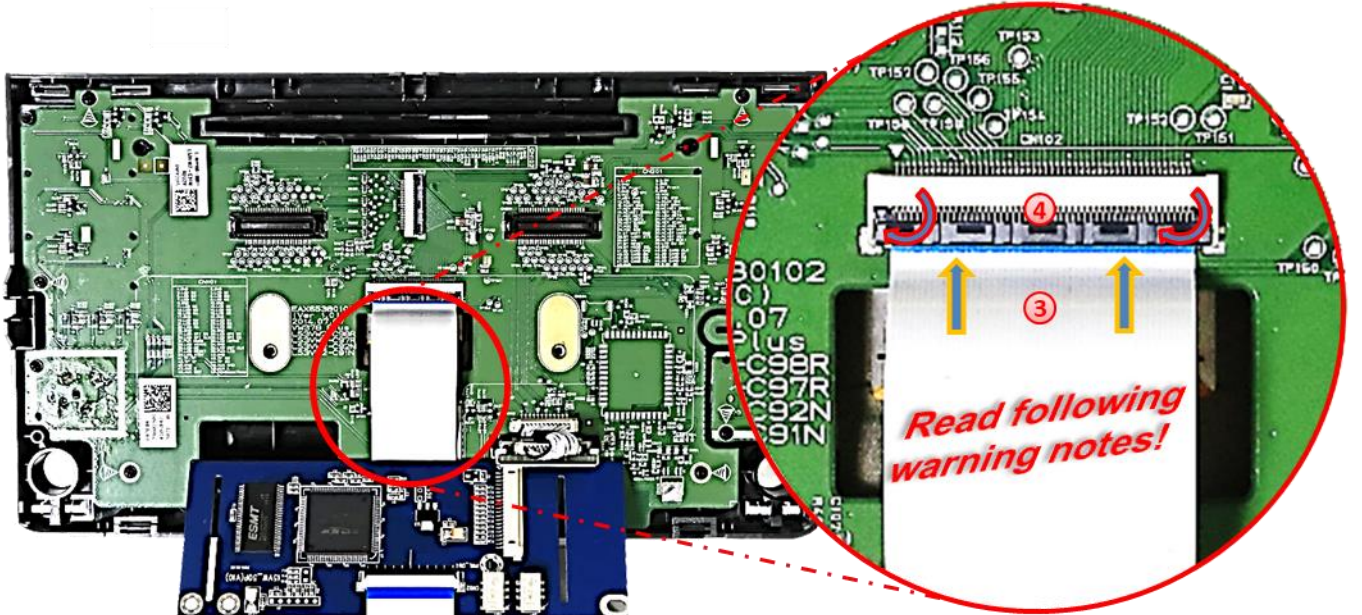

- 3 Connect the daughter PCB's 50pin ribbon cable „CAR-IN“ to the previously become free 50pin ribbon cable base of the factory PCB. Make sure that the connector pins are faced to the platinum.
- 4 After a check of its perfect position, close the ribbon cable base's lock by folding downwards the black hinge, to fix the connection again.

- 1 Carefully lead the monitor's brown colored 50pin ribbon cable into the preassembled ribbon cable merger of the daughter PCB's 50pin ribbon cable "PNL-OUT". Make sure that the connector pins are faced to the merger's platinum.
- 2 After a check of its perfect position, close the ribbon cable merger's lock, by folding back the black hinge, to fix the connection again.

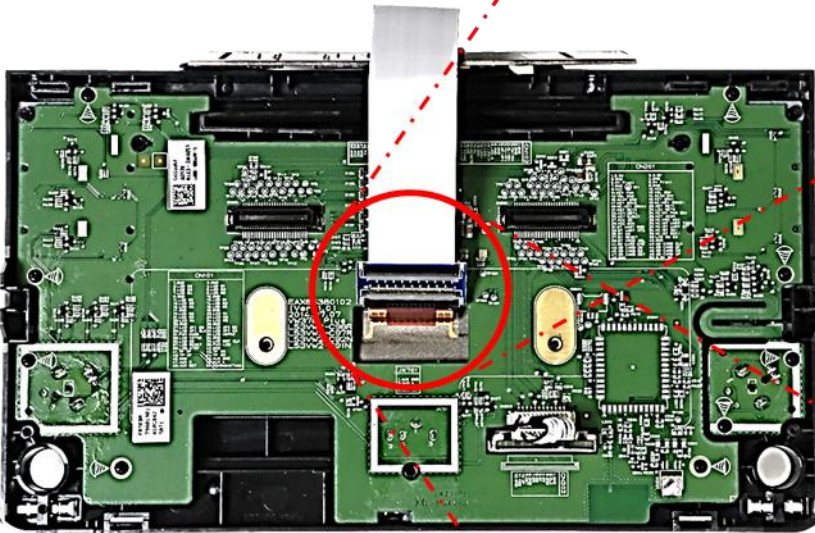
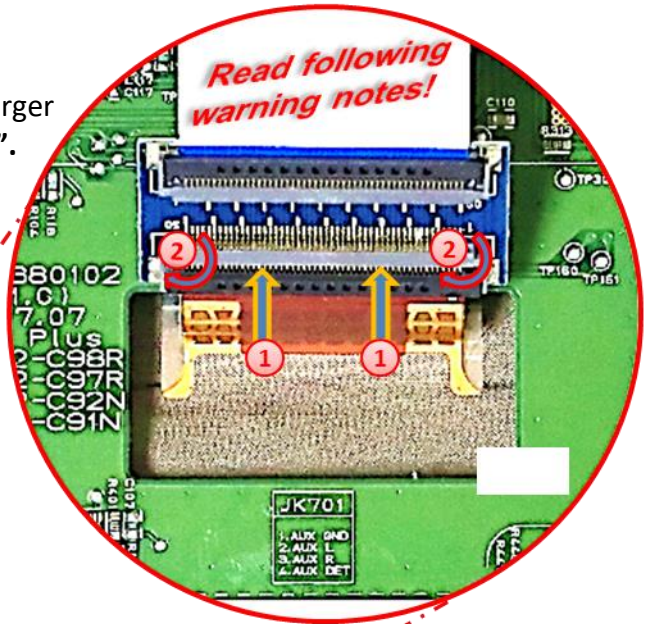

- 3 To avoid any kind of vibration-caused short circuits After the connection, it's necessary to isolate both sides of the merger with some kind of smooth issue tape as shown in the picture beside.

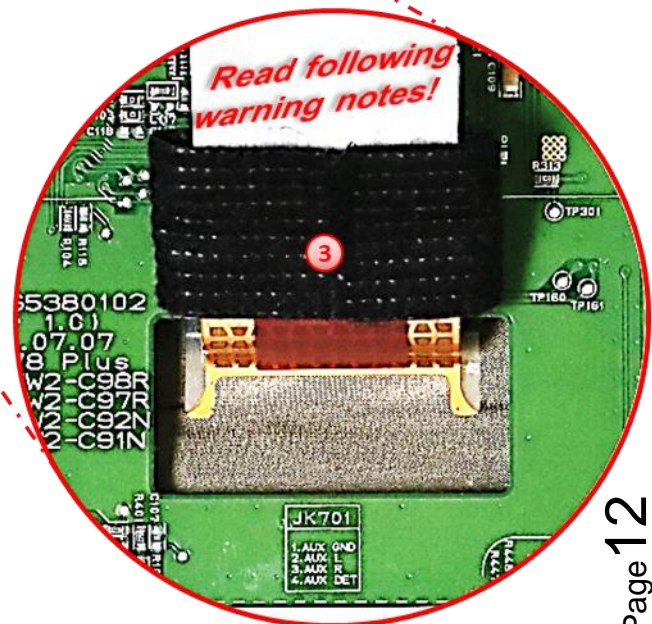

## 2.5.1. Warning notes, concerning the installation of ribbon cables

- 1) The contacting ends of ribbon cables always have to be installed in a straight and precise 180° position to the connector. Each deviation from a perfect contact position will cause faulty contact and even danger of short circuit
- 2) The ribbon cable's contacting side always has to correspond to the contacting side of the connector, concerning the mounting position.
- 3) Avoid cable contusion or cable injury caused by sharp-edged metal.

## 2.6. Closing the monitor's rear-side.

- 1) Before leading the daughter PCB through the monitor's rear metal sheet, it's further necessary to save both sides of the ribbon cables to avoid any kind of ribbon cable breakage, caused by vibrations of the metal parts. Use a smooth, but thin issue tape because there will be lack of space between the head unit's and the monitor's housing.

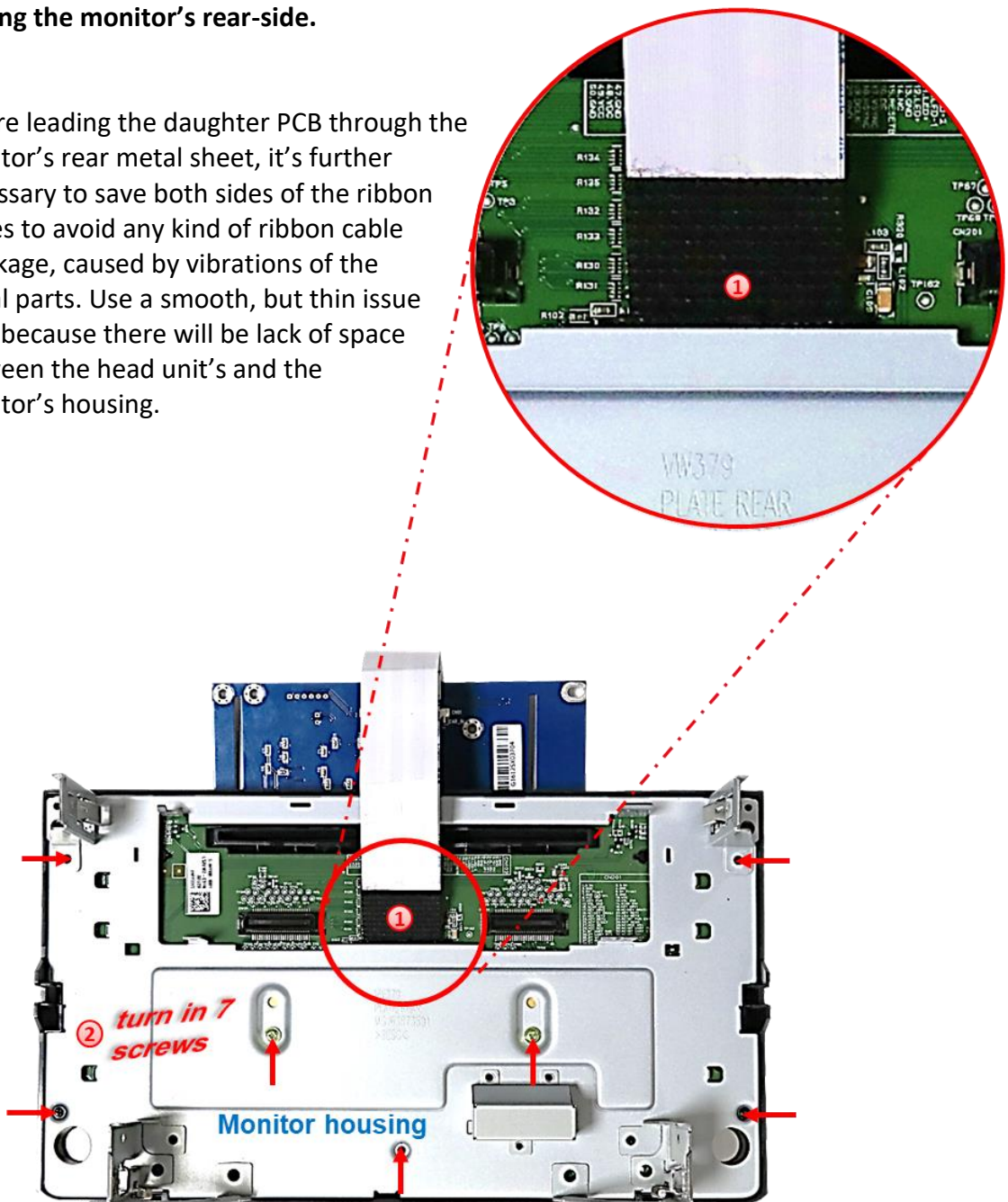

- 2) Fix the monitor's rear metal sheet by using the 7 screws.

## 2.7. Assembly - head unit, monitor and daughter PCB

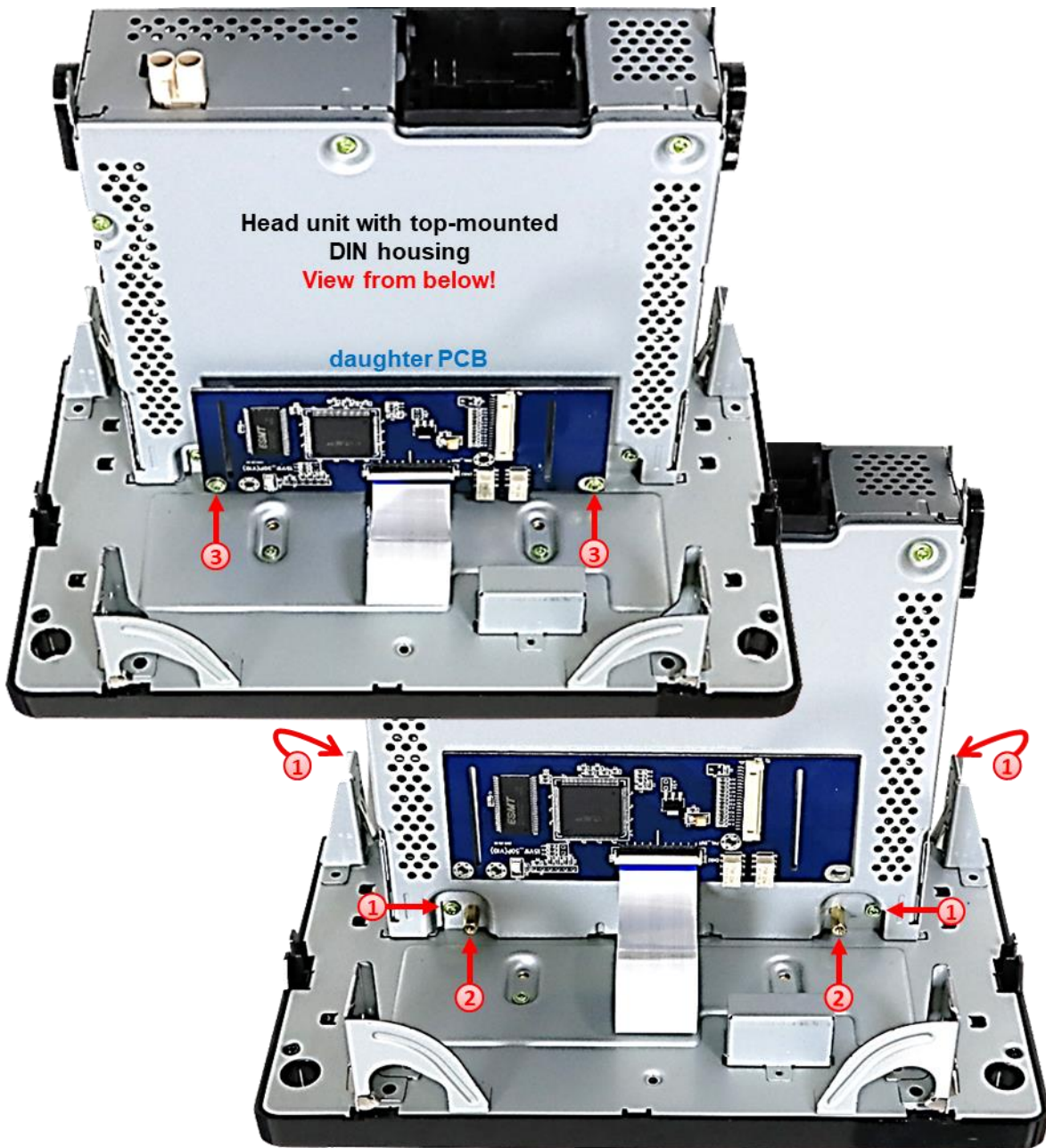

- 1 Carefully, plug the head unit into the monitor again and fix it with the 4 screws on its top and its bottom.

**Note:** Take special care for the ribbon cables for they won't be injured during the assembly of both parts!

- 2 Change the original brass screws against the enclosed brass spacers at the position that's shown in the picture.
- 3 Fix the daughter PCB to the brass spacers in the head unit by using the original screws.

## 2.8. Connection of the picture signal cable

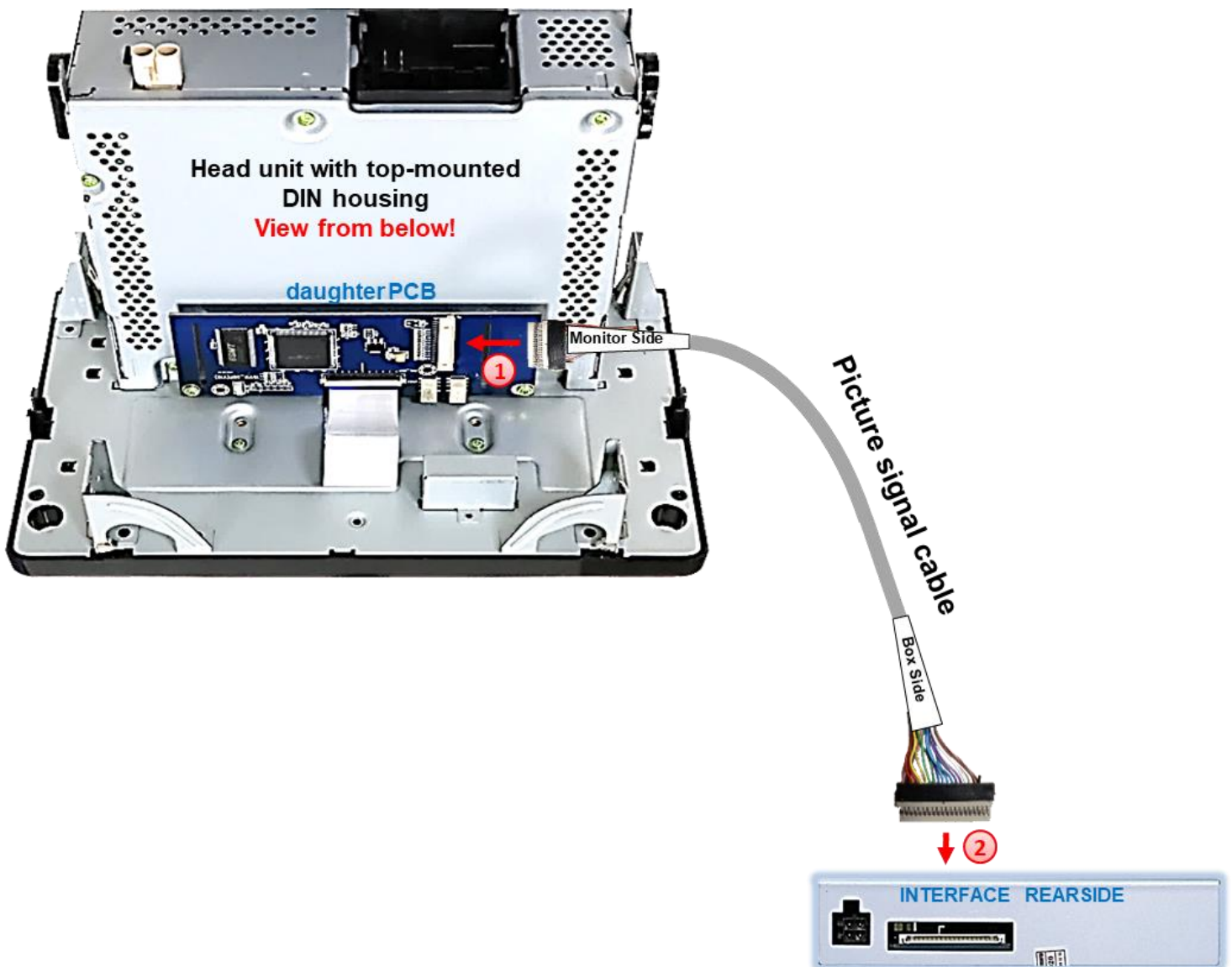

- 1 If not preassembled, connect the beige colored male 20pin connector (**Monitor Side**) of the 20pin picture signal cable to the female 20pin connector of the daughter PCB.
- 2 Connect the opposite beige colored male 20pin connector (**Box Side**) of the picture signal cable to the female 20pin connector of the video interface. Take care for installing the picture signal cable in the right direction, as both connectors seem to be identical. (Pay attention to the cable's caption "**MONITOR SIDE**" and "**BOX SIDE**")

## 2.9. Installation – Skoda vehicles.

For Skoda vehicles, the daughter PCB has to be installed inside the monitor. For that, it's necessary to separate the head unit housing from the monitor housing, for the required disassemble of the monitor mainboard behind the monitor panel. Due to the limited space inside the monitor housing, a shortening of the PCB is further required (see the following procedures).

## 2.9.1. Skoda monitor – removal and opening.



- 1 Turn out both screws at the **outer** side of the top part of the head unit (red arrows) and both screws at the bottom part of the head unit (red arrows). Separate the head unit from the monitor and lay it aside.

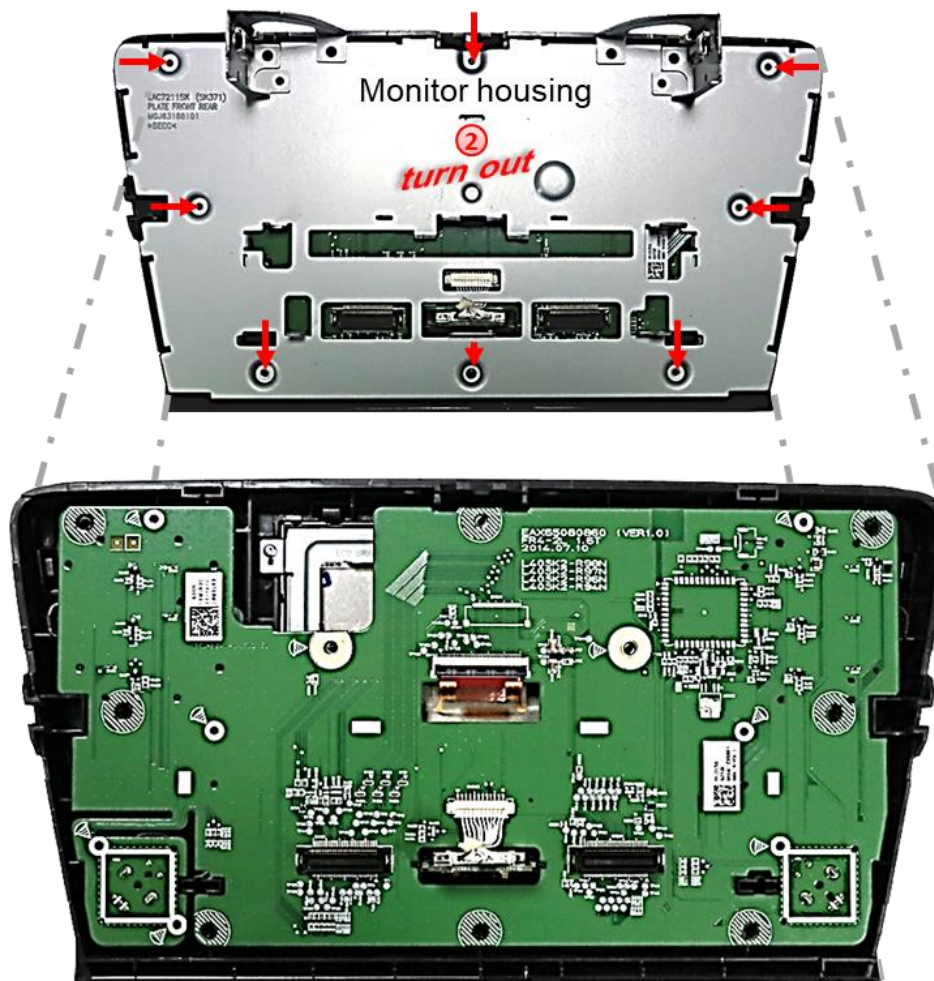

- 2 Turn out the 8 screws (red arrows) at the rear-side of the monitor and remove the metal sheet to set free the mainboard's ribbon cable base with the factory picture signal cable.



## 2.9.2. Skoda monitor mainboard – disconnection and removal

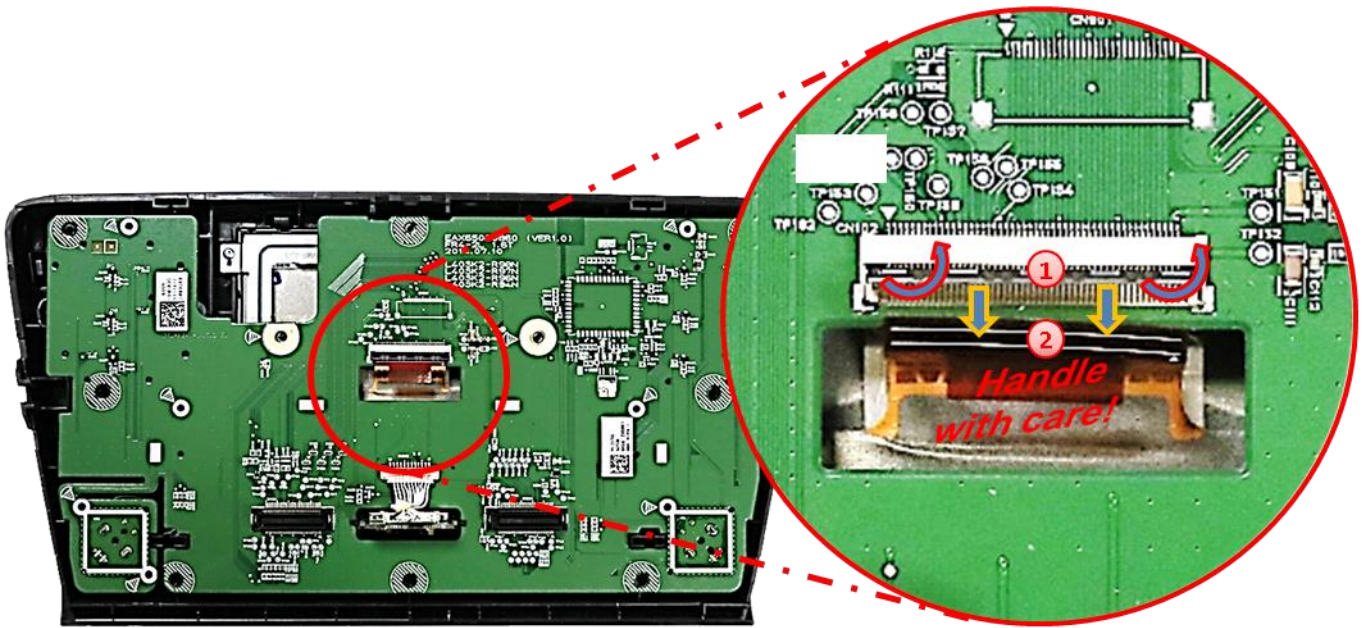

- 1 Fold upwards the black hinge of the factory ribbon cable base to unlock the original brown colored 50pin ribbon cable of the factory PCB.
- 2 Carefully pull out the original 50pin ribbon cable in arrow direction.

**Note: The original short ribbon cable is made by very stiff material. To avoid any breakage it mustn't be folded back to much, either while the installation nor with the final assembly.**

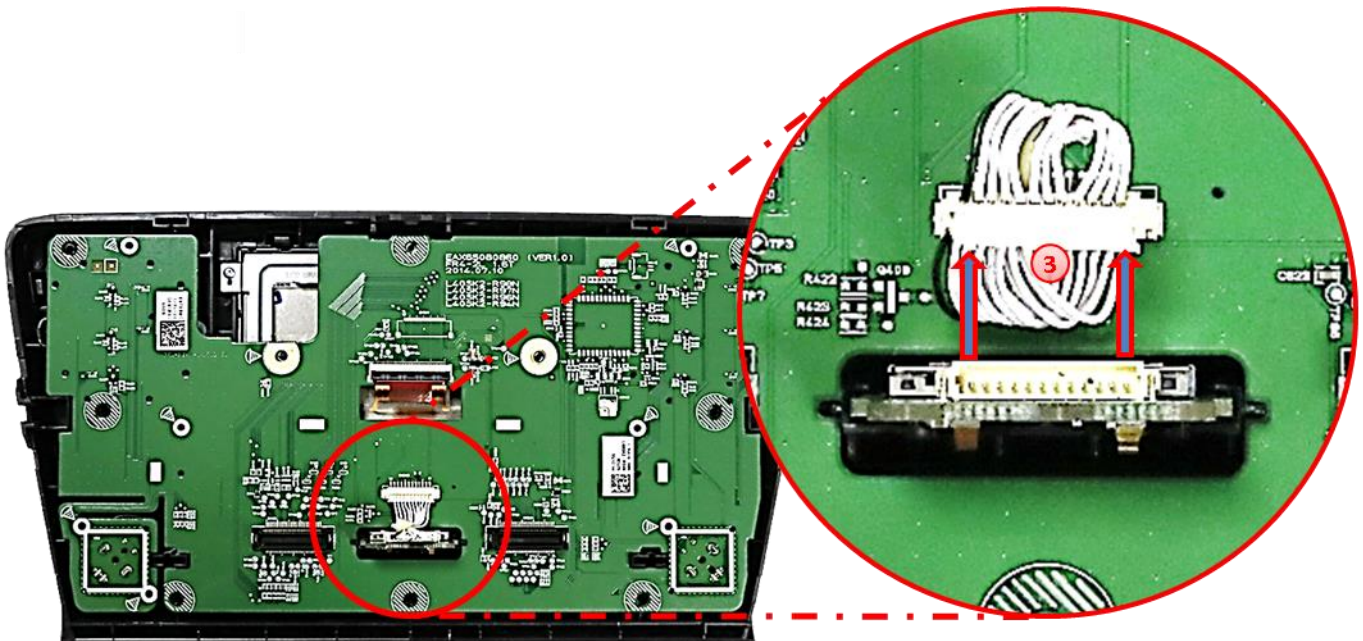

- 3 Disconnect the female 12pin connector from its 12pin SD card connector (keep connected at mainboard).

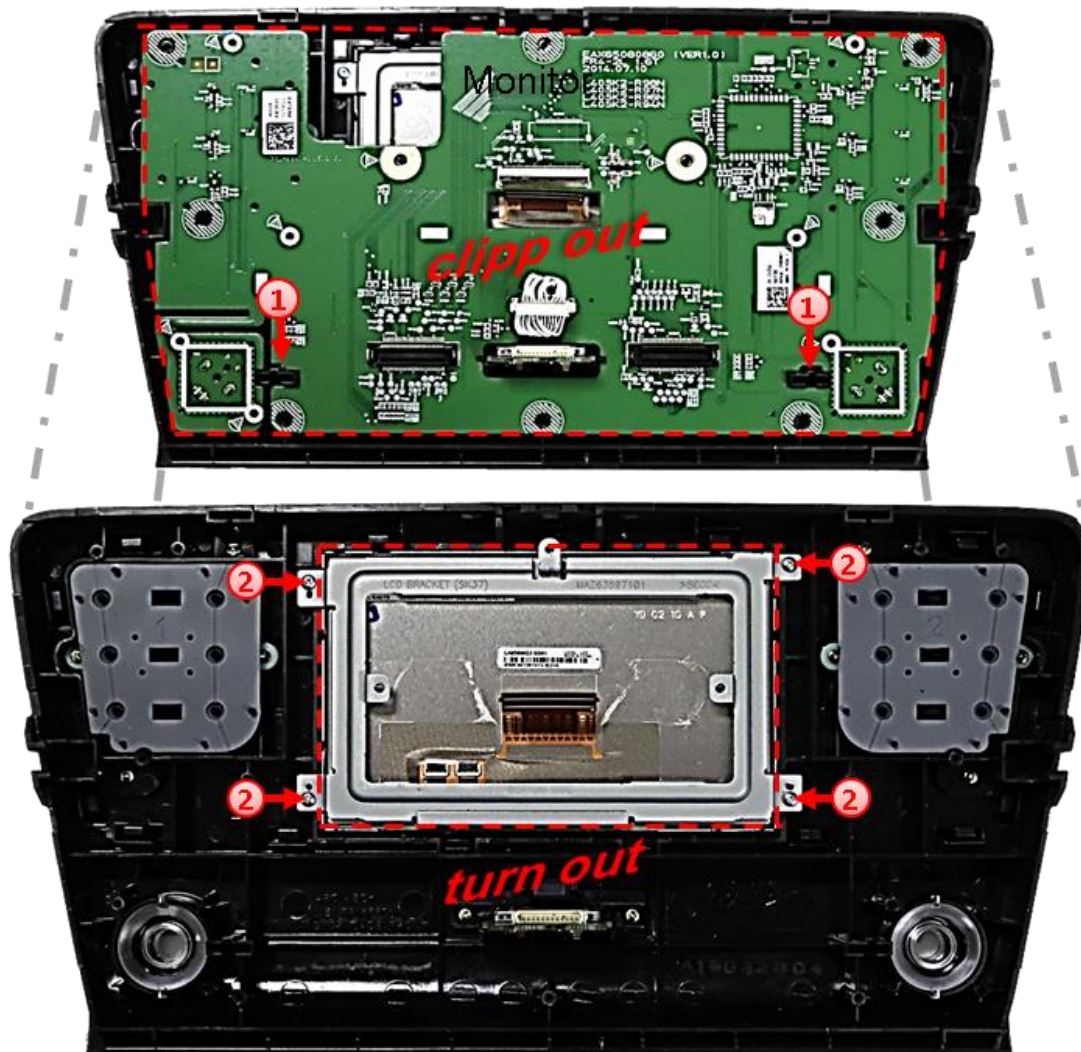

- 1 Clipp out the monitor's mainboard from the monitor's front housing and put it aside for setting free the monitor panel's metal frame and the 50pin ribbon cable for its connection to the daughter PCB.
- 2 Turn out the 4 screws and remove the monitor panel's metal frame.

### 2.9.3. Connection of the 50pin ribbon cables – Skoda vehicles

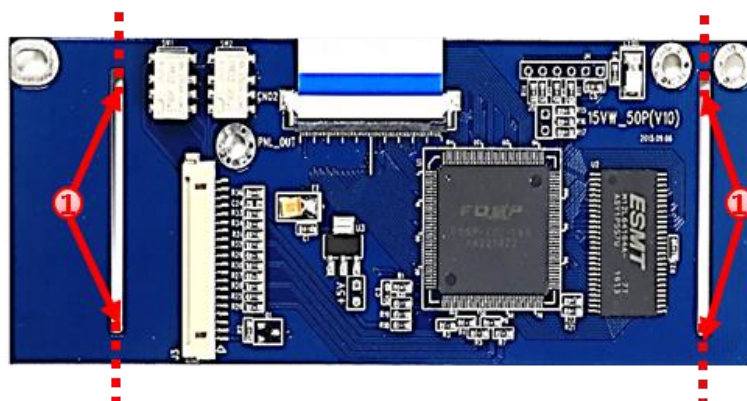

- 1 Carefully, sever the 4 predetermined breaking points of the daughter PCB and remove both side parts.

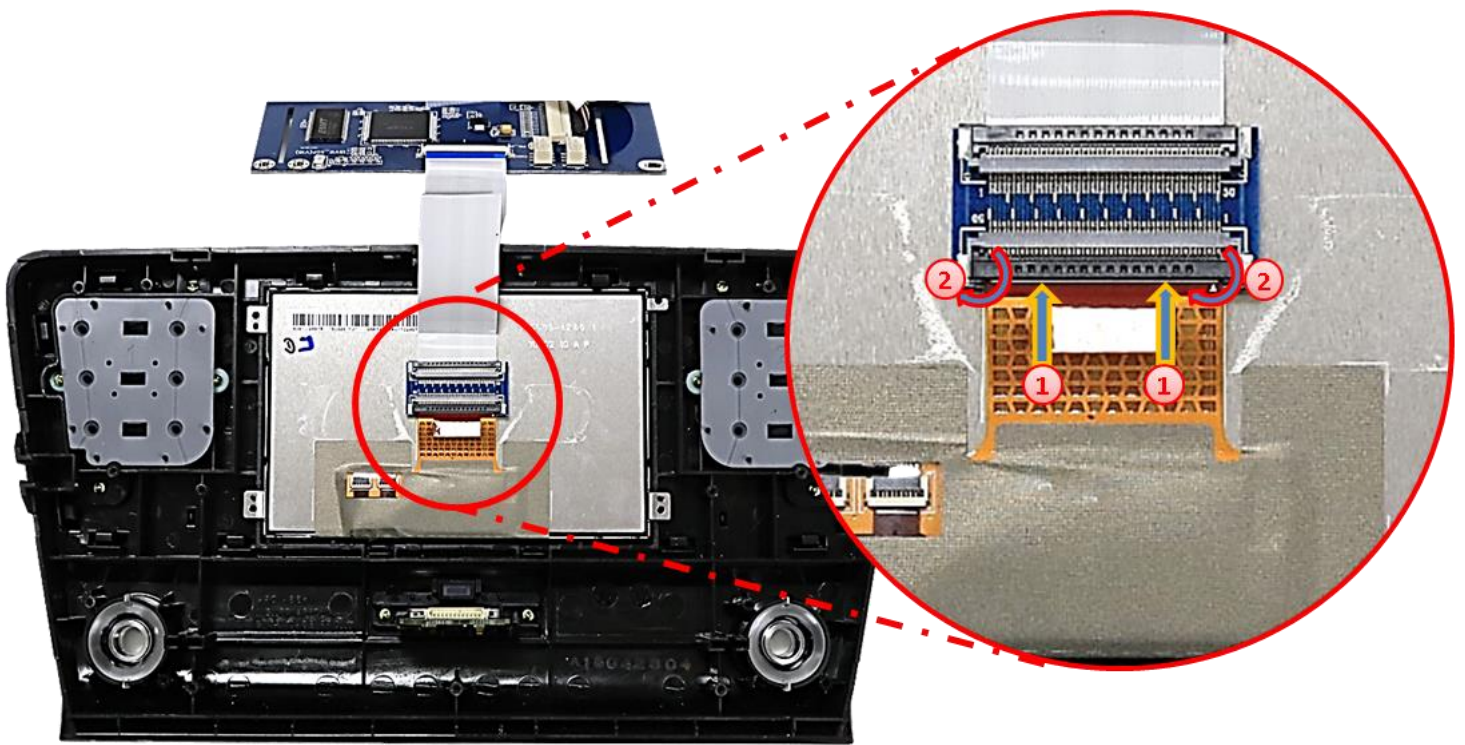

- 1 Carefully lead the monitor's brown colored 50pin ribbon cable into the preassembled ribbon cable merger of the daughter PCB's 50pin ribbon cable "PNL-OUT". Make sure that the connector pins are faced to the merger's platinum.
- 2 After a check of its perfect position, close the ribbon cable merger's lock, by folding back the black hinge, to fix the connection again.

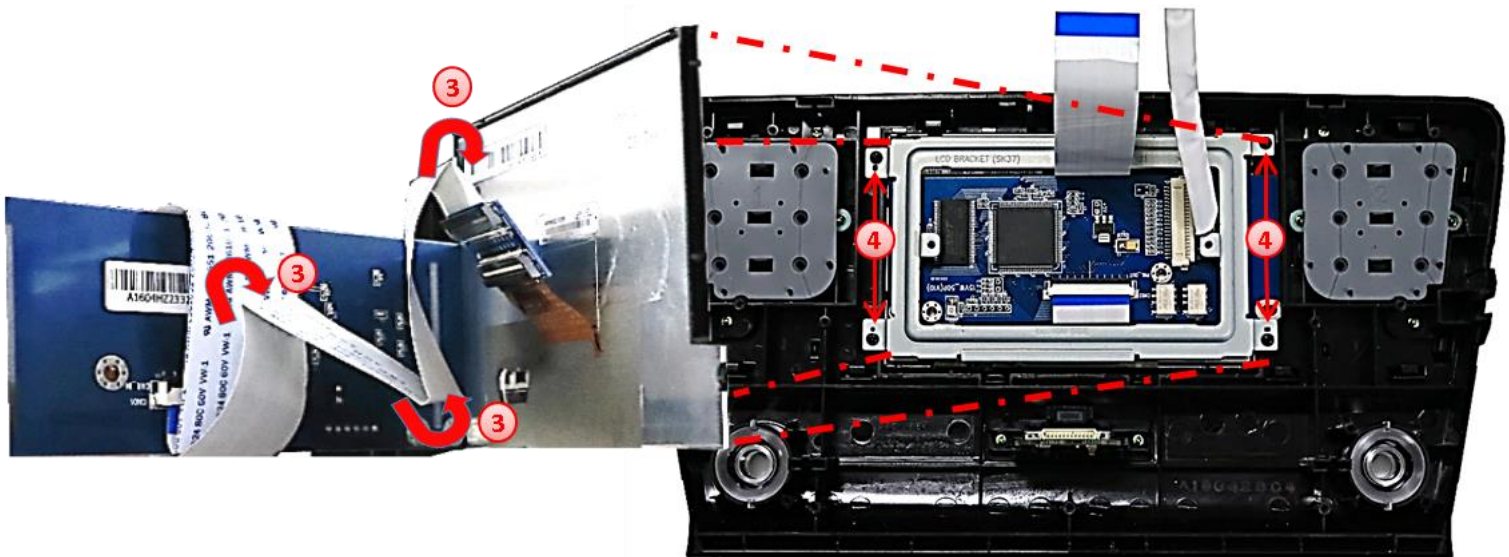

- 3 Fittingly, fold in the previously connected 50pin ribbon cable below the daughter PCB for installing the PCB, facing with its rear-side to the monitor panel.
- 4 After leading through the 50pin ribbon cable „CAR-IN“ and the picture signal cable, install the daughter PCB in the inner recess of the metal frame and fix the frame by using the 4 screws.

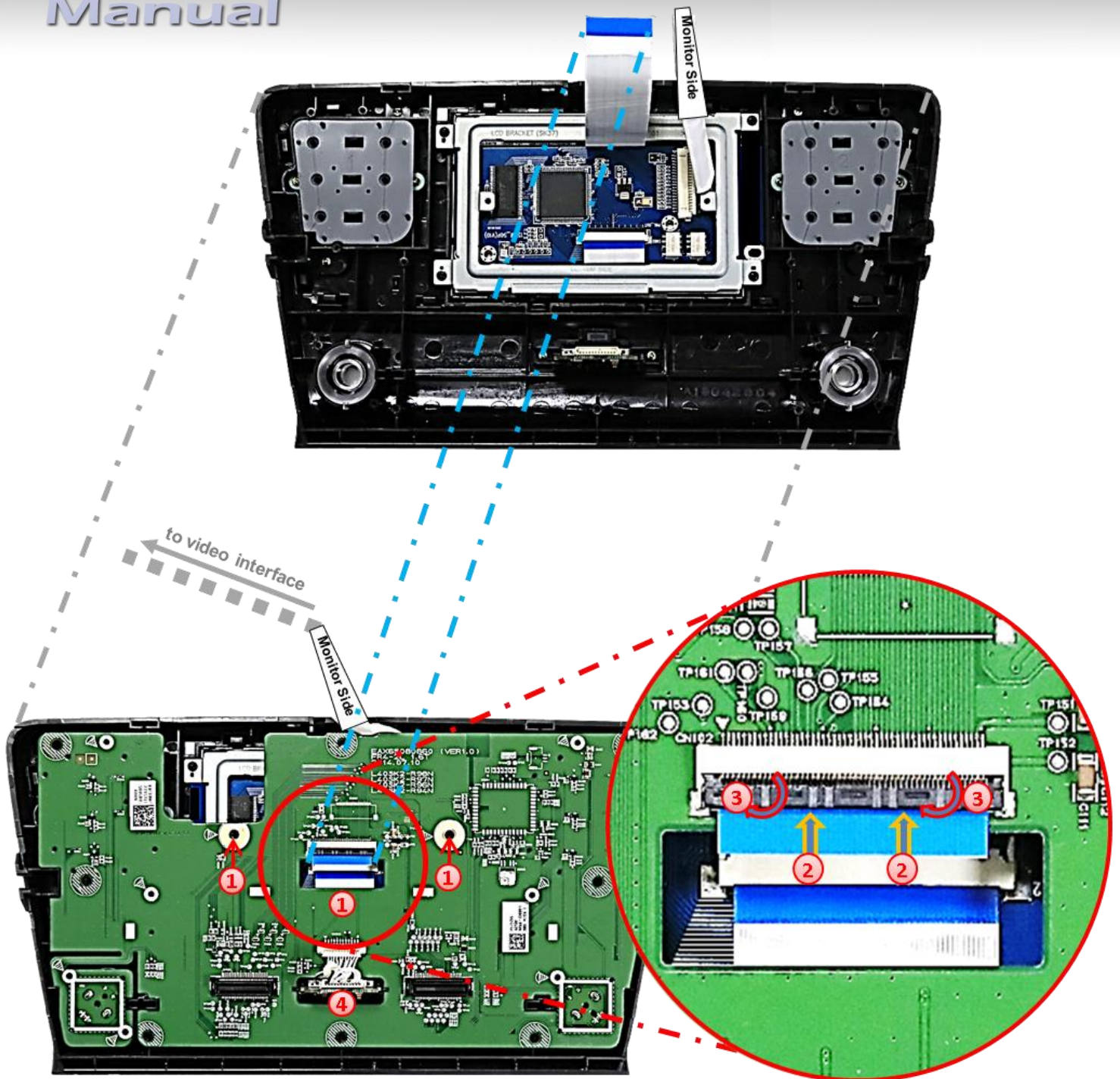

- 1 Hold the factory mainboard in its right position, lead the daughter PCB's 50pin ribbon cable „CAR-IN“ through its recess and again, fix the mainboard with two screws.
- 2 Connect the daughter PCB's 50pin ribbon cable to the factory mainboard's free ribbon cable base. Make sure that the connector pins are faced to the platinum.
- 3 After a check of its perfect position, close the ribbon cable base's lock by folding downwards the black hinge, to fix the connection again.
- 4 Reconnect the female 12pin connector to its 12pin SD card connector.

**Note:** Take special care for none-contacting of the PCB's electronical components to any other metal parts in the housing (isolate, where required!).

## 2.9.4. Reassembling – Skoda monitor and head unit

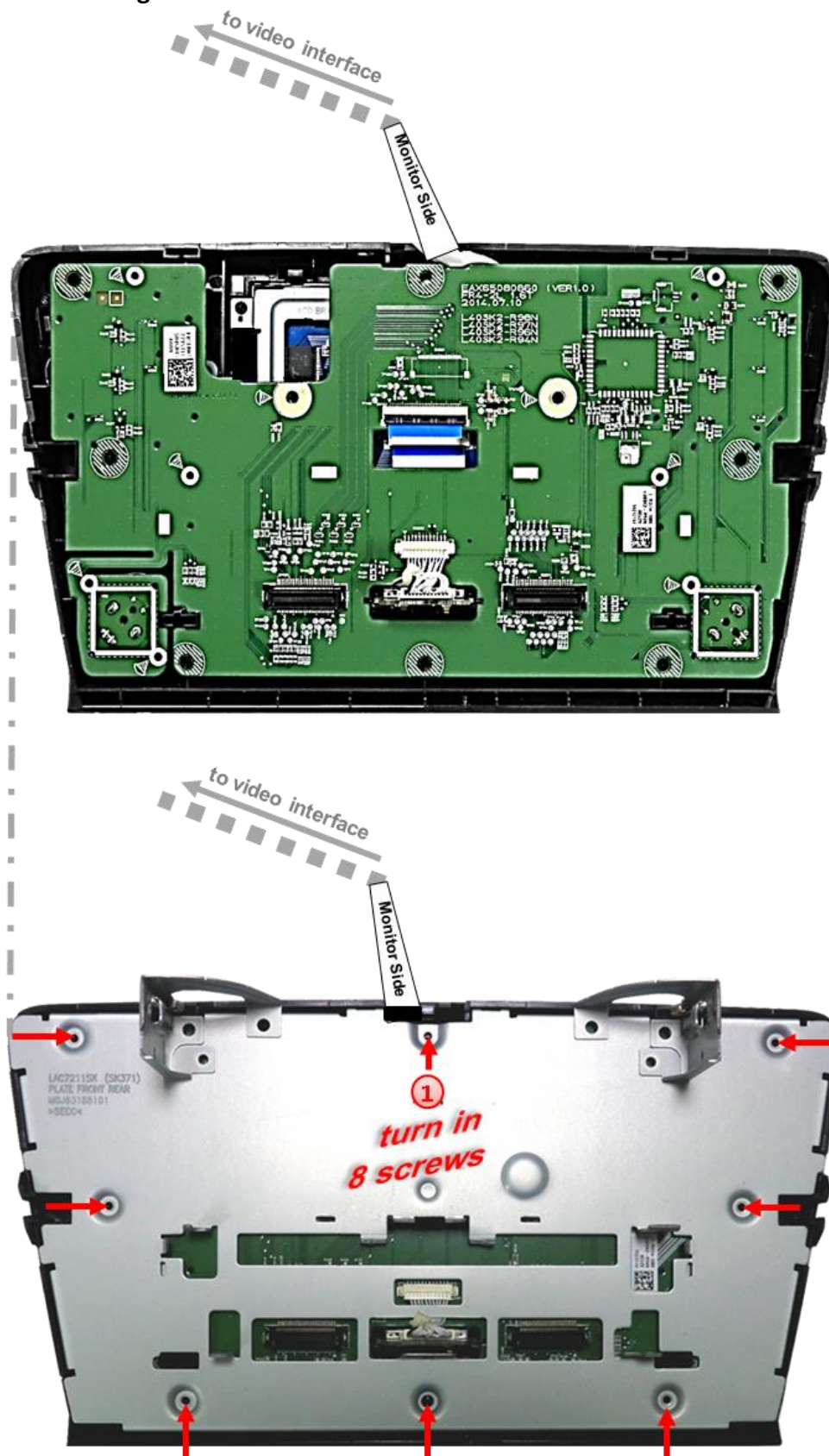

- 1 Lead the picture signal cable out at an appropriate location and reassemble the monitor's rear housing part by using the 8 screws.

**Note:** For the cable entry, a housing modification could possibly be required.

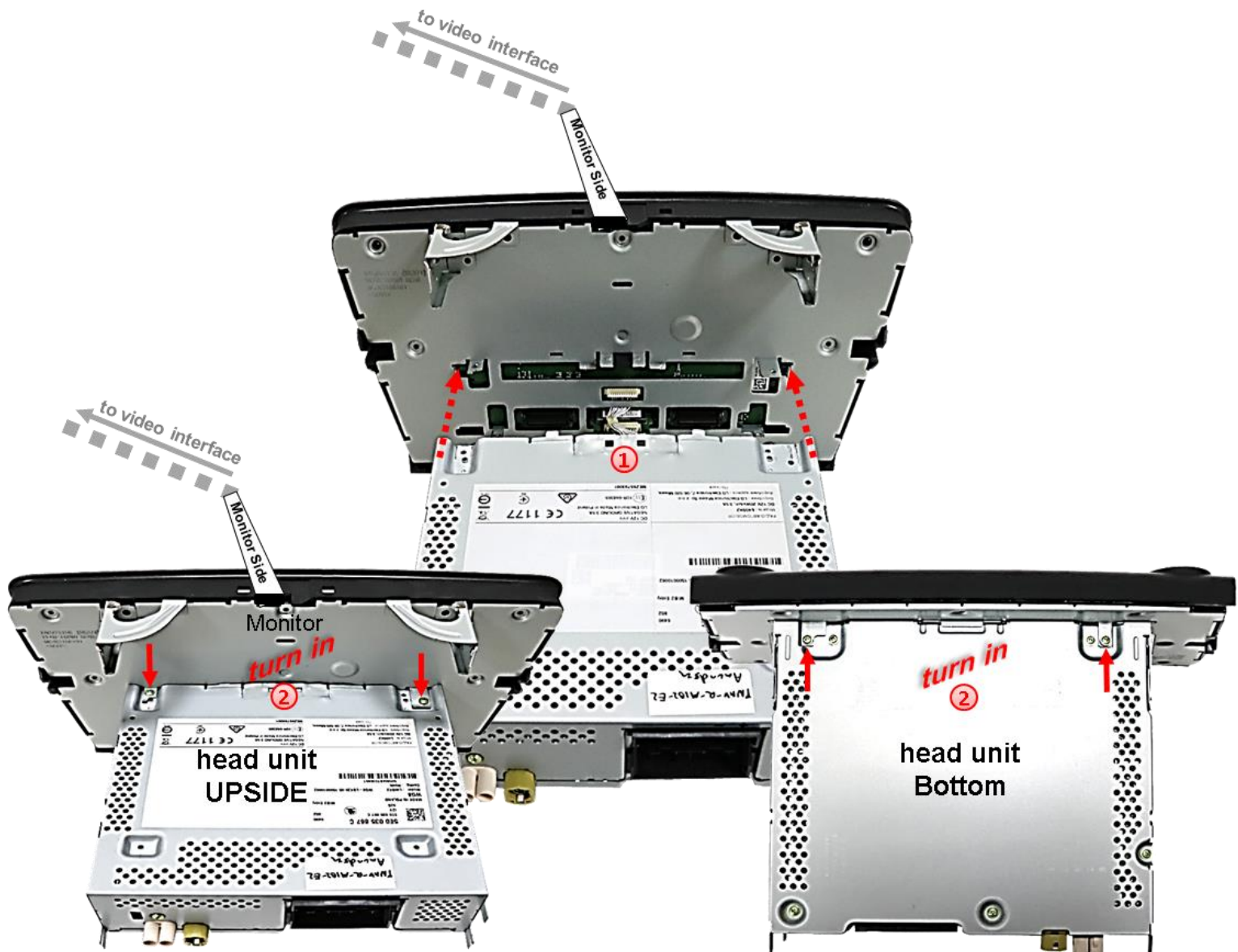

- 1** Reassemble the head unit housing to the monitor housing. Take special care for the perfect fitting of both parts and for not to get caught the small white cables of the 12pin connector.
- 2** Screw in both screws at the upside and both screws at the bottom of the head unit.

## 2.10. Connection - Video-sources

It is possible to connect two after-market video sources and one after-market rear-view camera to the video-interface.

Before final installation of the peripheral devices, we recommend a test-run to detect a incompatibility of vehicle and interface. Due to changes in the production of the vehicle manufacturer there's always a possibility of incompatibility.

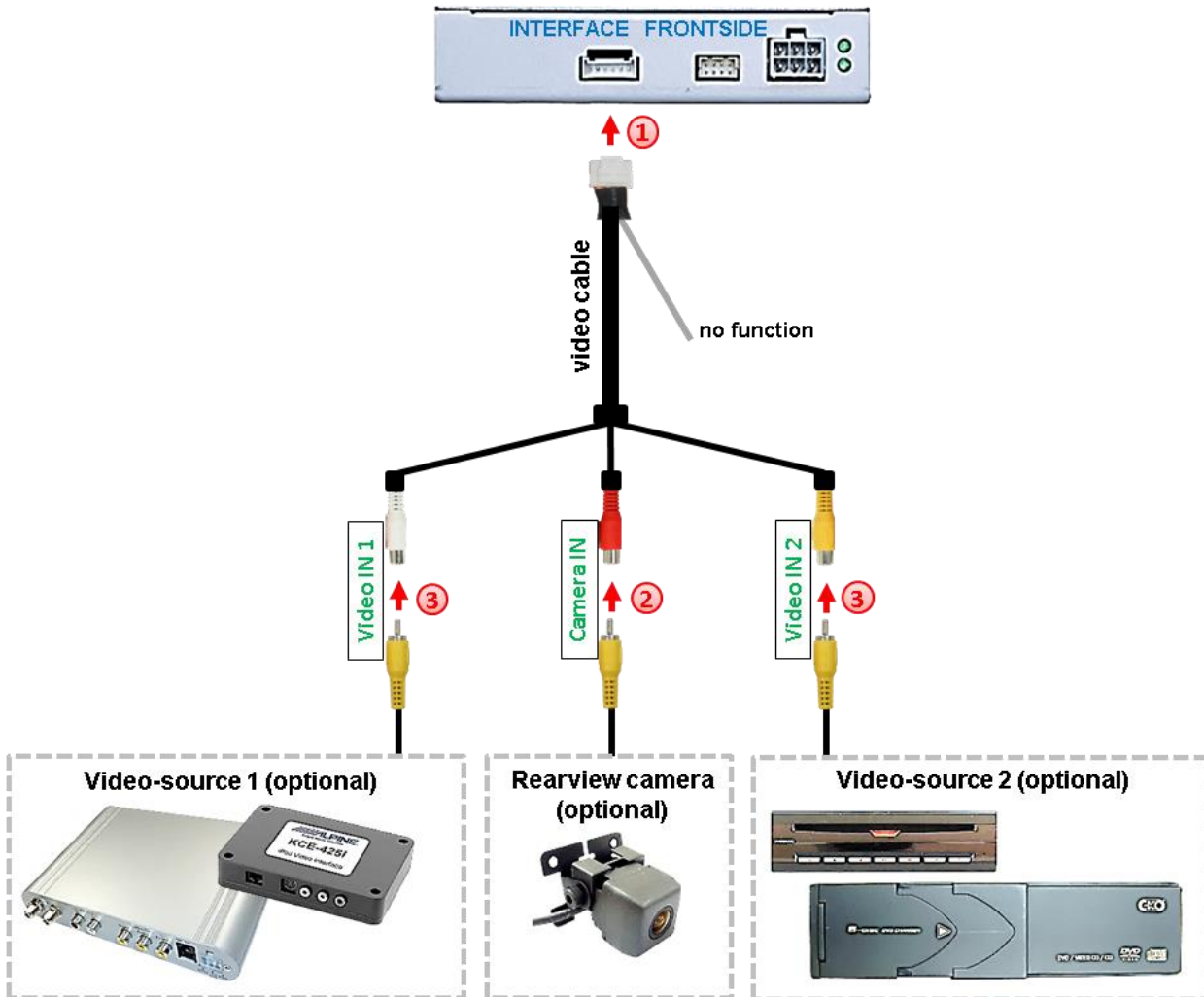

- 1 Connect the video cable's female 6pin connector to the video interface's male 6pin connector.
- 2 Connect the rear-view camera's RCA to the female RCA „**Camera IN**“ of the video cable.
- 3 Connect the RCA of the video source 1 and video source 2 to the female RCA „**Video IN1**“ and „**Video IN2**“ of the video cable.

## 2.11. After-market rear-view camera

**Note:** Do not forget to set dip5 of video-interface to ON before testing.

To switch to the rear-view camera when reverse gear is engaged, an external switching signal from the reverse gear light is required. As the reverse gear light signal contains electronic interference, a traditional open relay (e.g AC-RW-1230 with wiring AC-RS5) or filter (e.g. AC-PNF-RVC) is required. Below schema shows the use of a relay (normally open).

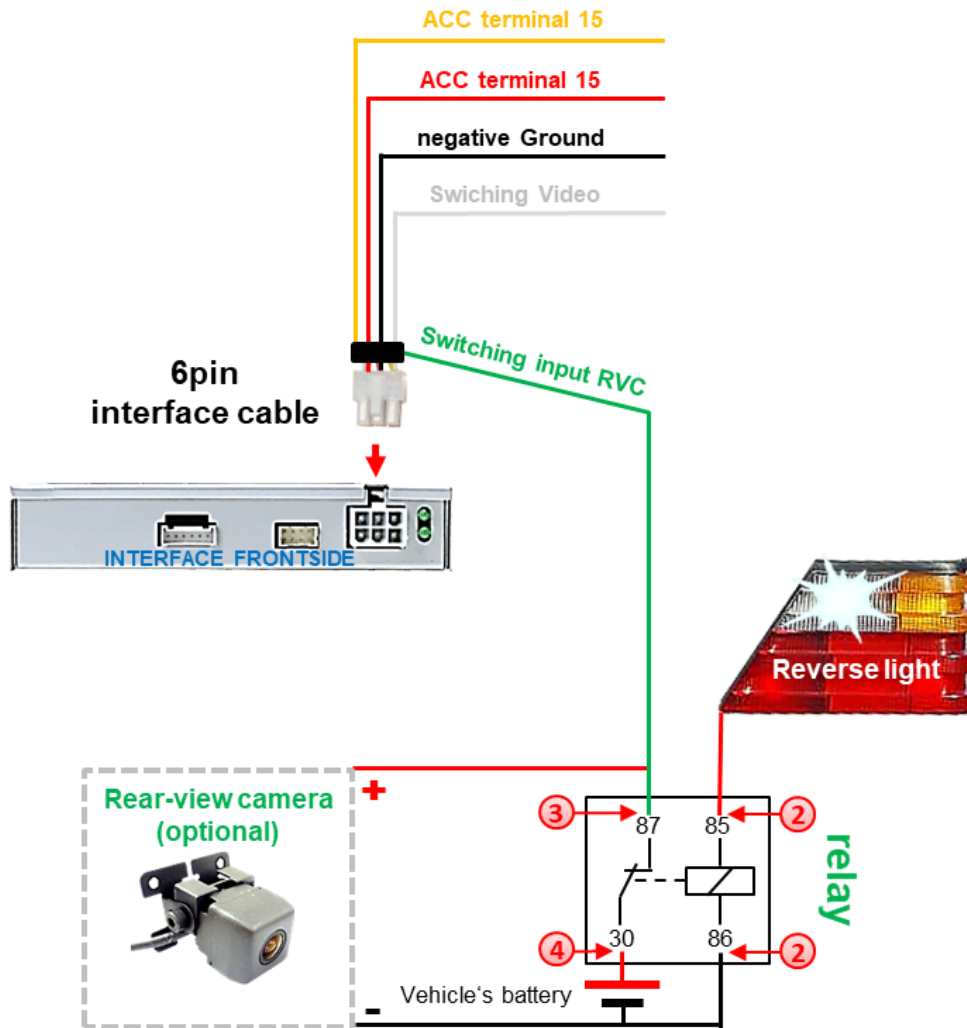

- ① Connect the green **switching input cable** to the output connector (87) of the relay.
- ② Connect the Reverse light's power-cable to coil (85) and the vehicle's ground to coil (86) of the relay.
- ③ Connect the output connector (87) of the relay to the rear-view camera's power-cable, like you did it to the green **switching input cable** before.
- ④ Connect stable and permanent +12V to the relay's input connector (30).



## 2.12. Audio-insertion

This interface is only able to insert video signals into the factory infotainment. If an AV-source is connected, the audio insertion has to be done by the factory audio AUX input or an FM-modulator. The inserted video-signal can be activated simultaneously to each audio-mode of the factory infotainment.

If 2 AV sources shall be connected to the infotainment, additional electronic is necessary to switch the audio signals.

## 2.13. Connection - Video Interface and external keypad

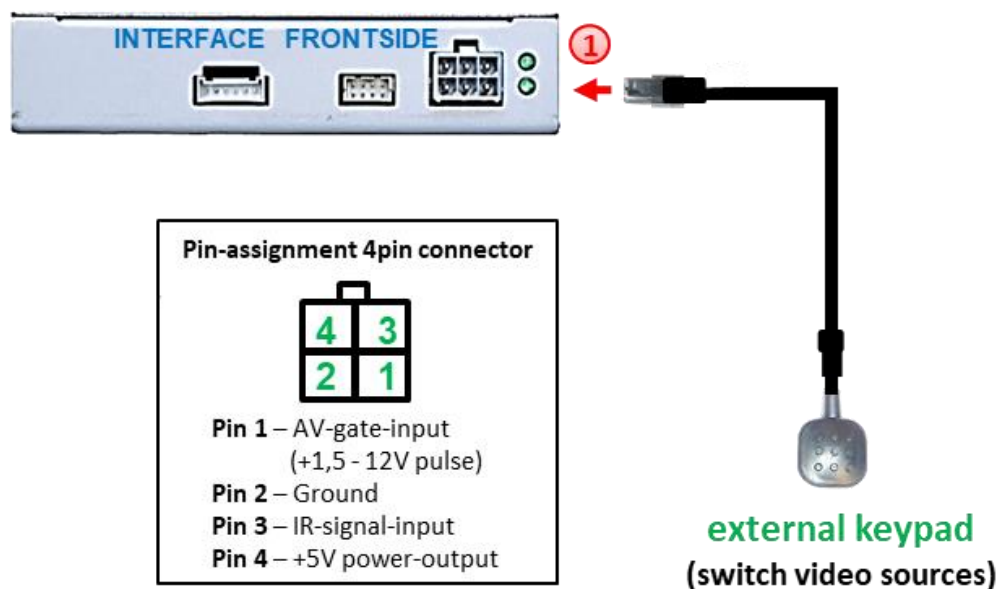

- 1 Connect the 4pin female connector of the external keypad to the male 4pin connector of the video interface.

**Note:** Regardless if it'll be used or not, the external keypad should always be connected! In case of non-using, it should be invisibly hidden together with the video interface.

## 2.14. Picture settings

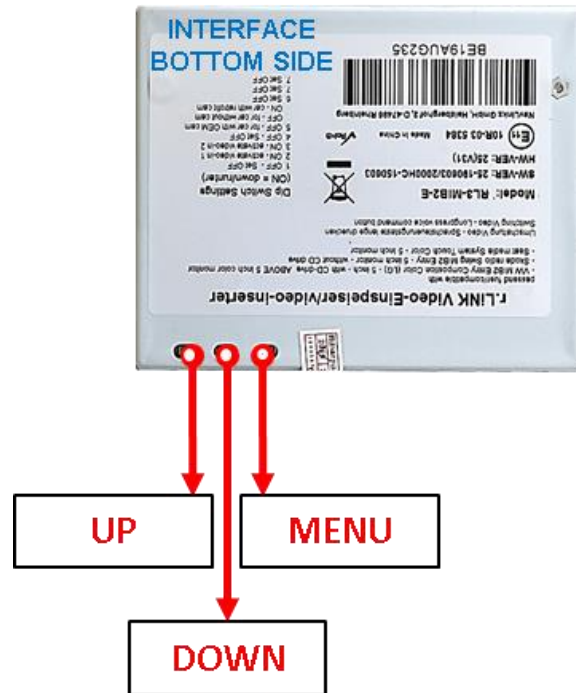

The picture settings are adjustable by the 3 push-buttons on the video-interface. Press the MENU button to open the OSD settings menu or to switch to the next menu item. Press UP and DOWN to change the selected value. The buttons are placed inside in the housing to avoid accidental changes during or after the installation. Picture settings must be done separately for AV1, AV2 and CAM while the corresponding input is selected and visible on the monitor.

**Note:** The OSD menu is only shown when a working video source is connected to the selected video-input of the interface.

The following settings are available:

- Contrast
- Brightness
- Saturation
- Position H = horizontal picture position
- Position V = vertical picture position
- IR-AV1/2 = no function
- Guide L/R = no function
- UI-CNTRL (no function) = no function
- H-SIZE = horizontal picture position
- V-SIZE = vertical picture position

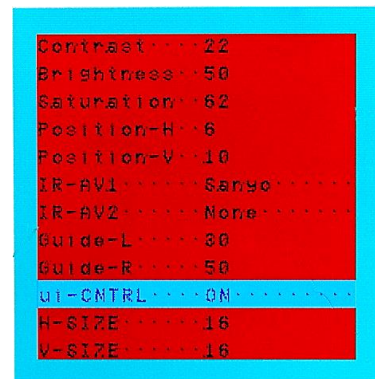

## 3. Video interface operation

The interface's external keypad can be used to switch the enabled inputs. Each press (2-3 seconds) will switch to the next enabled input. If all inputs are enabled the order is:

*Factory video → video IN1 → video IN2 → factory video →...*

Disabled inputs will be skipped.

### 3.1. By white wire of the 6pin interface cable

Alternatively or additionally to the external keypad, the white wire of the 6pin interface cable can be used to switch the enabled inputs.

**Every** +5V - +12V pulse for 2-3 seconds switches the video interface to the next enabled input.

## 4. Specifications

BATT/ACC range	7V - 25V
Stand-by power drain	10mA
Power	210mA
Video input	0.7V - 1V
Video input formats	NTSC
RGB-video amplitude	0.7V with 75 Ohm impedance
Temperature range	-40°C to +85°C
Dimensions video-box	114 x 25 x 98 mm (W x H x D)

## 5. FAQ – Trouble shooting Interface functions

For any troubles which may occur, check the following table for a solution before requesting support from your vendor.

Symptom	Reason	Possible solution
No picture/black picture (factory picture).	Not all connectors have been reconnected to factory head-unit or monitor after installation.	Connect missing connectors.
	No power on CAN-bus box (all LED CAN-bus box are off).	Check power supply of CAN-bus box. Check CAN-bus connection of CAN-bus box.
	CAN-bus box connected to CAN-bus in wrong place.	Refer to the manual where to connected to the CAN-bus. If not mentioned, try another place to connect to the CAN-bus.
	No power on video-interface (all LED video-interface are off).	Check whether CAN-bus box delivers +12V ACC on red wire output of 8pin to 6pin cable. If not cut wire and supply ACC +12V directly to video-interface.
No picture/black picture/white picture (inserted picture) but factory picture is OK.	No picture from video source.	Check on other monitor whether video source is OK.
	No video-source connected to the selected interface input.	Check settings dips 1 to 3 of video interface which inputs are activated and switch to corresponding input(s).
	LVDS cables plugged in wrong place.	Double-check whether order of LVDS cables is exactly connected according to manual. Plugging into head-unit does not work when the manual says to plug into monitor and vice versa.
Inserted picture totally wrong size or position.	Wrong monitor settings of video-interface.	Try different combinations of dips 7 and 8 of video-interface. Unplug 6pin power after each change.
Inserted picture double or 4 times on monitor.		
Inserted picture distorted, flickering or running vertically.	Video sources output set to AUTO or MULTI which causes a conflict with the interfaces auto detection.	Set video source output fixed to PAL or NTSC. It is best to set all video sources to the same standard.
	If error occurs only after source switching: Connected sources are not set to the same TV standard.	Set all video sources to the same standard.
	Some interfaces can only handle NTSC input.	Check manual whether there is a limitation to NTSC mentioned. If yes, set source fixed to NTSC output.
Inserted picture b/w.	Picture settings have not been adjusted.	Use the 3 buttons and the interface's OSD to adjust the picture settings for the corresponding video input.
Inserted picture qual. bad.		
Inserted picture size slightly wrong.		
Inserted picture position wrong.		
Camera input picture flickers.	Camera is being tested under fluorescent light which shines directly into the camera.	Test camera under natural light outside the garage.
Camera input picture is bluish.	Protection sticker not removed from camera lens.	Remove protection sticker from lens.

Symptom	Reason	Possible solution
Camera input picture black.	Camera power taken directly from reverse gear lamp.	Use relay or electronics to "clean" reverse gear lamp power. Alternatively, if CAN-bus box is compatible with the vehicle, camera power can be taken from green wire of 6pin to 8pin cable.
Camera input picture has distortion.		
Camera input picture settings cannot be adjusted.	Camera input picture settings can only be adjusted in AV2 mode.	Set dip 3 of video-interface to ON (if not input AV2 is not already activated) and connect the camera to AV2. Switch to AV2 and adjust settings. Reconnect camera to camera input and deactivate AV2 if not used for other source.
Graphics of a car in camera input picture.	Function PDC is ON in the interface OSD.	In compatible vehicles, the graphics will display the factory PDC distance. If not working or not wanted, set interface OSD menu item UI-CNTRL to ALLOFF.
Chinese signs in camera input picture	Function RET or ALL is ON (function for Asian market) in the interface OSD.	Set interface OSD menu item UI-CNTRL to ALLOFF or PDCON.
Not possible to switch video sources by OEM button.	CAN-bus interface does not support this function for vehicle.	Use external keypad or cut white wire of 6pin to 8pin cable and apply +12V impulses for AV-switching.
Not possible to switch video sources by external keypad.	Pressed too short.	For video source switching a longer press of about 2.5 seconds is required.
	SW-version of interface does not support external keypad.	Use OEM-button or cut white wire of 6pin to 8pin cable and apply +12V impulses for AV-switching.
Interface does not switch to camera input when reverse gear is engaged.	CAN-bus interface does not support this function for the vehicles.	Cut the green wire of the 6pin to 8pin cable and apply +12V constant from reverse gear-lamp signal. Use relay to "clean" R-gear lamp power.
Interface switches video-sources by itself.	CAN-bus interface compatibility to vehicle is limited.	Cut the grey wire of 6pin to 8pin and isolate both ends. If problem still occurs, additionally cut the white wire of 6pin to 8pin cable and isolate both ends.

## 6. Technical Support

Please note that direct technical support is only available for products purchased directly from NavLinkz GmbH. For products bought from other sources, contact your vendor for technical support.

**NavLinkz GmbH**  
**distribution/tech dealer-support**  
 Heidberghof 2  
 D-47495 Rheinberg

Tel +49 2843 17595 00  
 Email mail@navlinkz.de

 10R-03 5384

Made in China

