

v.LiNK Video-inserter

VL2-MBN4

**for Mercedes Benz vehicles
with
Comand APS HD NTG3, Comand APS NTG4,
Audio20 NTG4 and Audio50 APS NTG4 Navigation
Systems
with 10pin LVDS connector on the monitor**

Video-inserter with 2 video + RGB + rear-view camera input and CAN control

Product features

- **Video-inserter for factory-infotainment monitors**
- **2 CVBS video-inputs for after-market devices (e.g. DVD-Player, DVB-T tuner, ...)**
- **Built-in audio-switch (no audio-insertion)**
- **CVBS Rear-view camera video-input**
- **Automatic switching to rear-view camera input on engagement of reverse gear**
- **RGB-input for after-market navigation**
- **Video-in-motion (ONLY for connected video-sources)**
- **Compatible with factory rear-view camera**
- **AV-inputs PAL/NTSC compatible**

Contents

1. Prior to installation

- 1.1. Delivery contents
- 1.2. Checking the compatibility of vehicle and accessories
- 1.3. Boxes and connectors
 - 1.3.1. Video-interface
 - 1.3.2. CAN-bus box
 - 1.3.2.1 Dip-switch settings
 - 1.3.2.2 Enabling the interface's video inputs (dip 1-3)
 - 1.3.2.3 RGB-video input signal selection for after-market navigation (Dip 4)
 - 1.3.2.4 Rear-view camera setting (dip 5)
 - 1.3.2.5 Monitor selection (dip 7-8)

2. Installation

- 2.1. Place of installation
- 2.2. Connection scheme
- 2.3. Connecting video-interface and CAN-Box
- 2.4. Connection of the factory monitor
- 2.5. Connecting peripheral devices
 - 2.5.1 After-market RGB navigation
 - 2.5.2 Video-sources to AV1 and AV2
 - 2.5.3 Audio-switch and audio-insertion
 - 2.5.4 After-market rear-view camera
 - 2.5.4.1 Video signal connection
- 2.6 Connecting video-interface and keypad
- 2.7 Picture settings

3. Interface operation

- 3.1. By Command-buttons
- 3.2. By keypad

4. Specifications

5. Frequently asked questions

6. Technical Support

Legal Information

By law, watching moving pictures while driving is prohibited, the driver must not be distracted. We do not accept any liability for material damage or personal injury resulting, directly or indirectly, from installation or operation of this product. This product should only be used while standing or to display fixed menus or rear-view-camera video when the vehicle is moving, for example the MP3 menu for DVD upgrades.

Changes/updates of the vehicle's software can cause malfunctions of the interface. We offer free software-updates for our interfaces for one year after purchase. To receive a free update, the interface must be sent in at own cost. Labor cost for and other expenses involved with the software-updates will not be refunded.

1. Prior to installation

Read the manual prior to installation.

Technical knowledge is necessary for installation. The place of installation must be free of moisture and away from heat sources.

1.1. Delivery contents

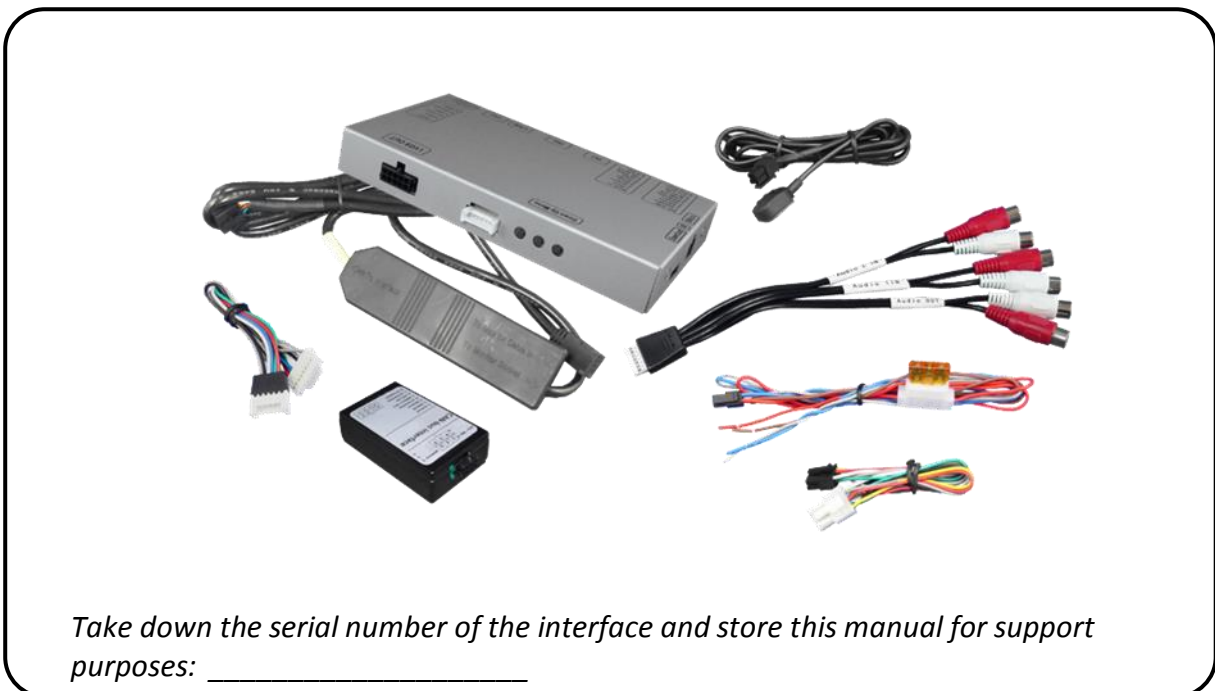

1.2. Checking the compatibility of vehicle and accessories

Requirements	
<i>Vehicle</i>	Mercedes Benz C-class (W204) from 03/2007 till 02/2011, CL-class (C216) from 01/2006 till 05/2009, CLC-class (CL203) from 09/2008, E-class (W212) from 04/2009 till 05/2011, E-class Coupe (W207) from 05/2009 till 05/2011, CLS-Coupe (C218) from 01/2011 till 05/2011, GLK-class (X204) from 09/2008, S-class (W221) from 10/2005 till 05/2009, SLS (C197) from 03/2010
<i>Head-unit/monitor</i>	Comand APS HD NTG3, Comand APS NTG4, Audio20 NTG4, Audio50 APS NTG4 With 10-PIN LVDS connector on the monitor
Limitations	
<i>Video only</i>	The interface inserts ONLY video signals into the infotainment. For sound use the possibly existing factory-audio-AUX-input or a FM-modulator.
<i>Factory rear-view camera</i>	Automatic switch-back from inserted video to factory rear -view camera only while reverse gear is engaged. To delay the switch-back time, additional electronics is required

1.3 Boxes and connectors

1.3.1 Video Interface

The video-interface converts the connected after-market sources video signals to an LVDS signal which is the inserted into the factory monitor on certain trigger options.

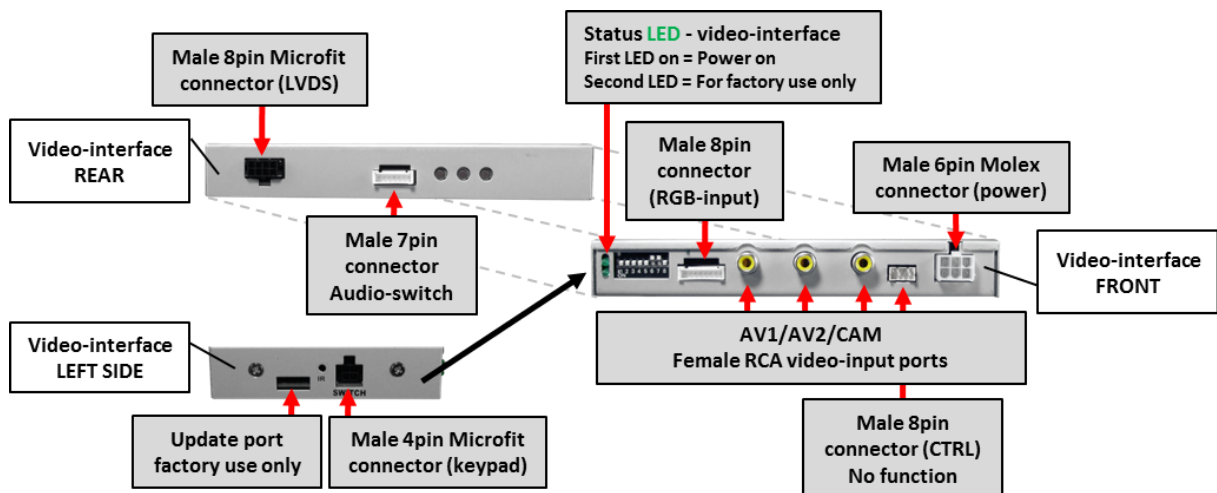

1.3.2 CAN-Bus Box

The CAN-bus box reads digital signals from the CAN-bus and converts them for the video-interface.

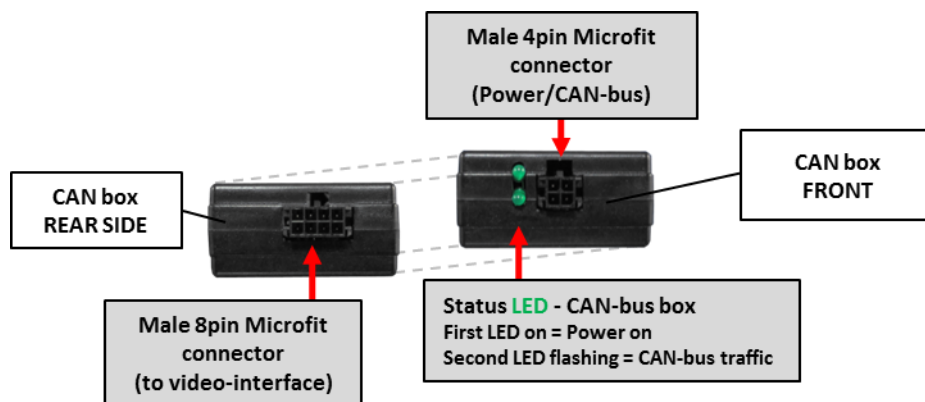

1.3.2.1 Dip-switch settings

Some settings must be selected by the dip-switches on the video-interface. Dip position down is ON and position up is OFF.



Dip	Function	ON (down)	OFF (up)
1	RGB-input	enabled	disabled
2	CVBS AV1-input	enabled	disabled
3	CVBS AV2-input	enabled	disabled
4	RGB-input resolution	RGB 800x480 VGA 640x480	RGB NTSC 480x240
5	Rear-view cam type	after-market	factory or none
6	No function	-	set OFF
7	Monitor selection	Try all 4 possible combinations of dip 7 and 8 to find the best picture (quality and size)	
8	Monitor selection		

See following chapters for detailed information.

1.3.2.2. Enabling the interface's video inputs (dip 1-3)

Only the enabled video inputs can be accessed when switching through the interface's video sources. It is recommended to enable only the required inputs for the disabled will be skipped when switching through the video-interfaces inputs.

1.3.2.3. RGB-video input signal selection for after-market navigation (Dip 4)

If an after-market RGB navigation or other RGB video source is connected, the source's RGB output signal must match the interface's RGB video input setting.

1.3.2.4. Rear-view camera setting (dip 5)

If set to OFF, the interface switches to factory LVDS picture while the reverse gear is engaged to display factory rear-view camera or factory optical park system picture.

If set to ON, the interface switches to its rear-view camera input CAM while the reverse gear is engaged.

1.3.2.5. Monitor selection (dip 7-8)

Dip 7 and 8 are for monitor-specific video settings which cannot be predicted as even within the same head-unit version, the monitor specifications may vary. It is necessary to try all possible combinations (both OFF, both ON, 7 OFF and 8 ON, 7 ON and 8 OFF) - while a working video source is connected to the chosen input of the interface - to see which combination gives the best picture quality and size (some may give no picture). It is possible to first hot plug through the dip combinations, but if you do not experience any change of picture after trying all 4 options, retry and disconnected the 6pin power plug of the video-box between every change of the dip setting.

2. Installation

Switch off ignition and disconnect the vehicle's battery! The interface needs a permanent 12V source. If according to factory rules disconnecting the battery is to be avoided, it is usually sufficient to put the vehicle in sleep-mode. In case the sleep-mode does not show success, disconnect the battery with a resistor lead.

If power source is not taken directly from the battery, the connection has to be checked for being start-up proven and permanent.

2.1. Place of installation

The interface is installed on the backside of the vehicle's monitor.

2.2. Connections

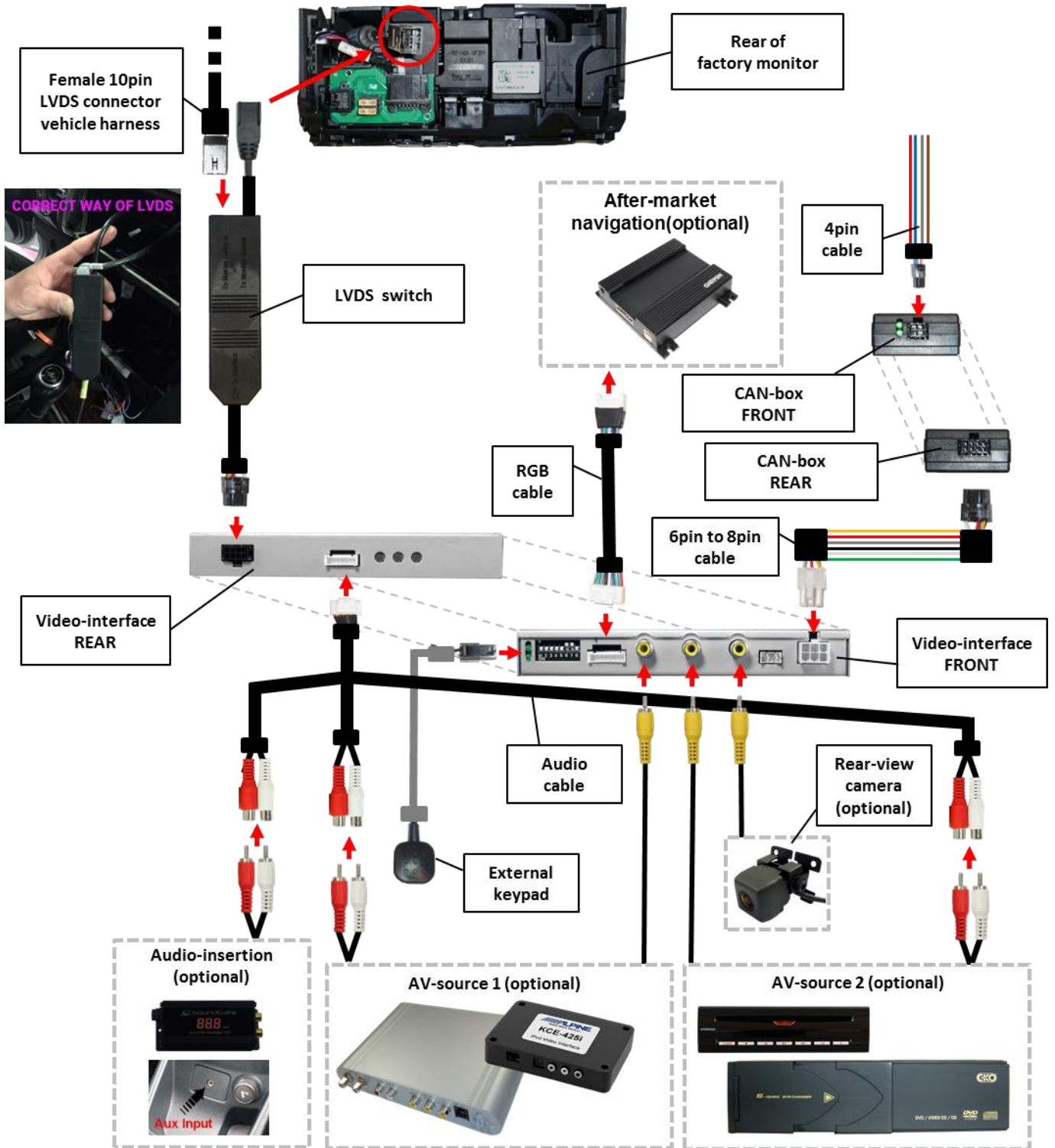

2.3. Connecting video-interface and CAN-box

The CAN-bus box reads digital signals from the CAN-bus and converts them for the video-interface. ACC +12V max. 0.5A (red of 6pin) and reverse gear +12V max. 0.5A (green of 6pin) constant signal. Video-source switching (white of 6pin) as +12V impulse.

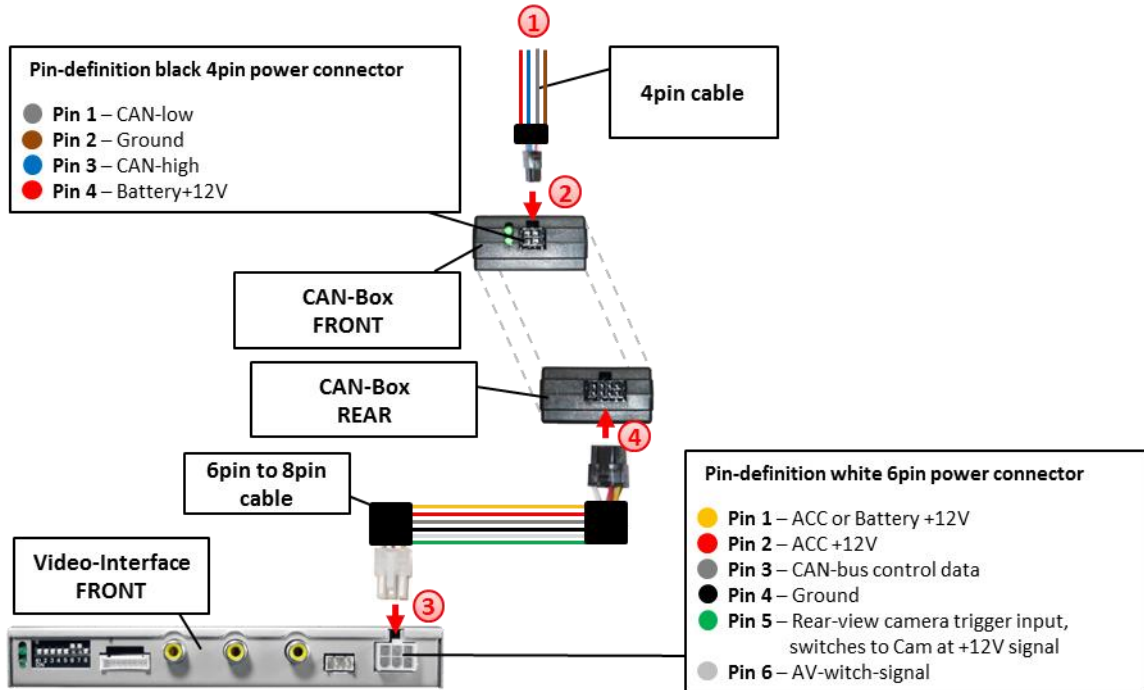

- ① Connect CAN-bus and power at the factory monitor. The connector can be different to the pictured connector.

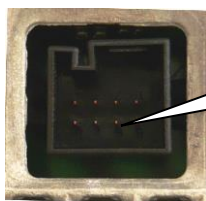

Pin-definition
4321
8765

Pin-Definition 8-Pin Power Connector To the Factory Monitor	
Pin 2	Battery+12V
Pin 1	Ground
Pin 3 (Pin 8, 2011er E-Kl.)	CAN-HIGH
Pin 4 (Pin 4, 2011er E-Kl.)	CAN-LOW

No liability for vehicle wire colors and pin definition!
Possible changes by the vehicle manufacturer. The given information must be verified by the installer.

- ② Connect black female 4pin Microfit connector of the Quadlock harness to the male 4pin Microfit connector of the CAN-box.

Note: Check LEDs on CAN-box after reconnecting the battery, two must be on.

- ③ Connect white female 6-pin Molex connector of the 6pin to 8pin cable to the male 6pin Molex connector of the video-interface.
- ④ Connect black female 8pin Microfit connector of the 6pin to 8pin cable to male 8pin Microfit connector of the CAN-box.

Note: Check LEDs on video-interface after reconnecting the battery, one must be on.

Note: The CAN-box is not compatible with all vehicles. If the CAN-box does not deliver ACC to pin2 of the video-interface or blocks the vehicle CAN, it is possible to install without CAN-box. In this case see also note in chapter after-market rear-view camera if one is supposed to be connected.

2.4. Connections to the factory monitor

Remove factory monitor.

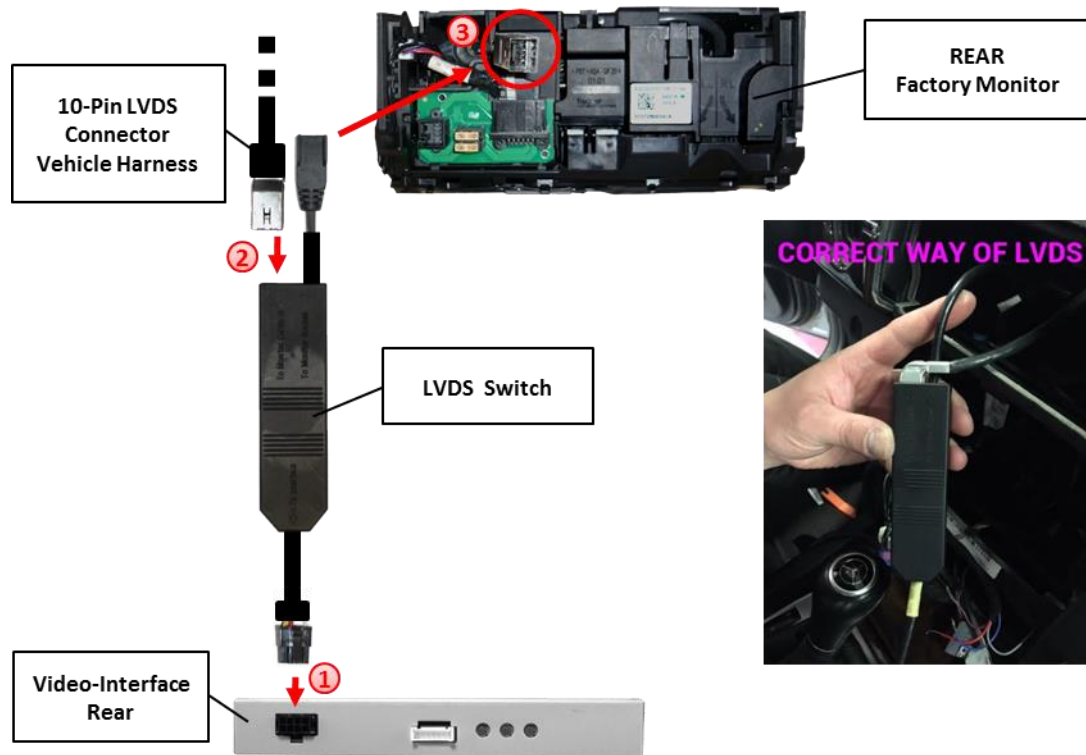

- ① Connect 10pin Microfit connector of the LVDS Switch to the 10pin Microfit connector of the video-interface.
- ② Transfer vehicle harness' 10pin LVDS connector from factory monitor to male 10pin connector port of the LVDS switch-box
- ③ Connect female 10pin LVDS connector to 10pin LVDS connector port of the factory monitor

2.5. Connection of peripheral devices

It is possible to connect an After-Market RGB navigation (or another RGB source), two After-Market AV sources and an After-Market rear view camera to the video-interface

Before final installation we recommend a test run to make sure that vehicle and interface are compatible. Due changes within the production line of the vehicle manufacturer the risk of incompatibility always exists.

2.5.1. After-Market RGB-Navigation

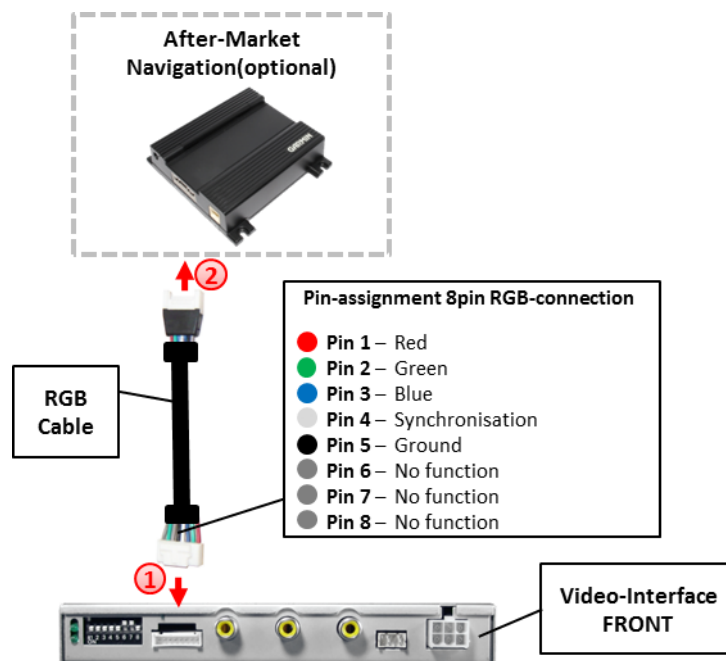

- ① Connect female 8pin connector of the RGB cable to the male 8pin connector of the video-interface. The loose grey wires have no function and have to be isolated.
- ② Connect male 6pin connector of the RGB cable to the after-Market navigation.

2.5.2. Video-sources to AV1 and AV2

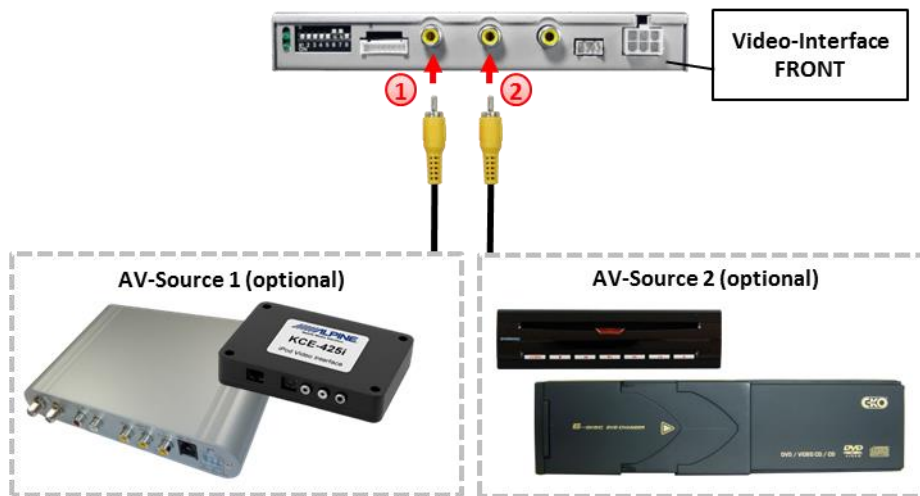

- ① Connect video RCA of the AV-source 1 to the female RCA connector Video 1 of the video cable.
- ② Connect video RCA of the AV-source 2 to the female RCA connector Video 2 of the video cable.

2.5.3 Audio-switch and audio insertion

This interface can only insert video signals into the factory infotainment and switch audio signals. If an AV-source is connected to AV1 or AV2, audio insertion must be done by factory audio AUX input or FM-modulator to which the interface's sound-switch output is connected. When the interface is switched from AV1 to AV2, the audio signal is switched parallel to the corresponding video signal by the interface's built-in audio-switch. The inserted video-signal can be activated simultaneously to each audio-mode of the factory infotainment.

Audio pins	Definition
1/2	Audio input signal R/L of source AV2
3/4	Audio input signal R/L of source AV1
5/6	Audio output signal R/L of factory audio AUX or FM-modulator
7	Ground

Note: If only one AV-source shall be connected, it is possible to connect the video output of the AV-source to the video input AV1 of the video-interface and the audio output of the AV-source directly to the point of audio-insertion (e.g. audio AUX input).

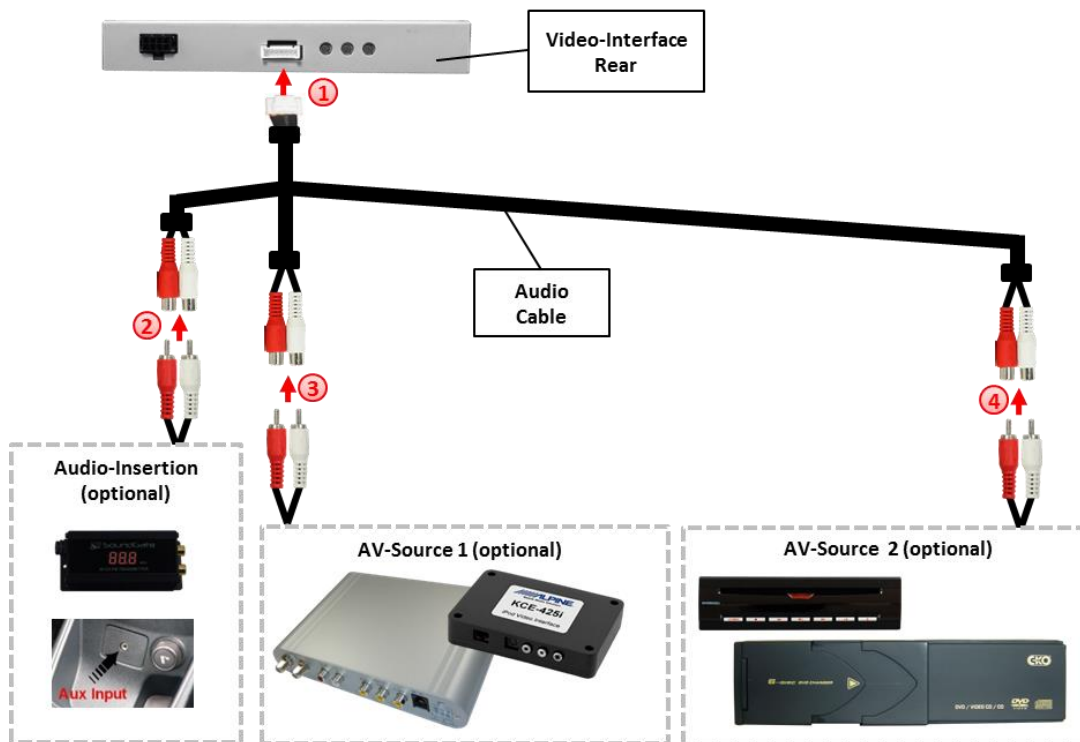

- ① Connect female 7pin connector of the audio cable to male 7pin connector of the video-interface.
- ② Connect the audio-RCA of the possibly existing factory AUX-input or the FM-modulator to the female RCA port AV-Out of the audio cable.
- ③ Connect the audio-RCA of the AV-source 1 to the corresponding AV1 RCA ports of the audio cable.
- ④ Connect the audio-RCA of the AV-source 2 to the corresponding AV2 RCA ports of the audio cable.

2.5.4. After-market rear-view camera

Because the Can Bus Box does not support the reverse signal, an external signal by the back driving light is required. Because the back driving signal contains electronic disturbances, a jailer's relay (e.g., AC-RW-1230 with wiring AC-RS5) or a noise filter (e.g., AC-PNF-RVC) is required. The lower chart shows the use of a relay (jailer).

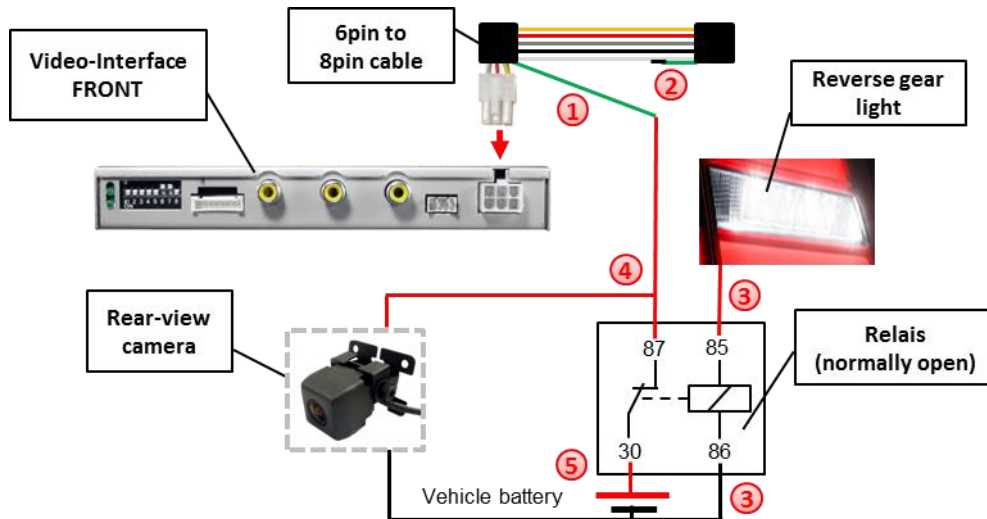

- ① Cut the green cable of the 6pin to 8pin cable close to the black 8pin connector.
- ② Isolate the short end of the green wire (CAN-box side).
- ③ Connect reverse gear light signal/power to coil (85) and ground to coil (86) of relais.
- ④ Connect rear-view camera power and green wire (video-interface side) of 6pin to 8pin cable to output (87) of relay.
- ⑤ Connect permanent battery power to input (30) of relay.

2.5.4.1 Video signal connection

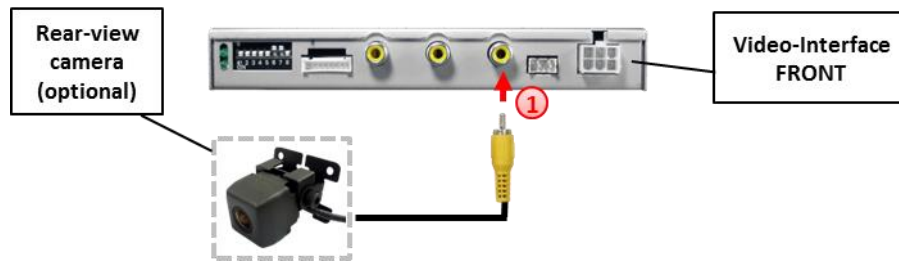

- ① Connect the video-RCA of the after-market rear-view camera to the female RCA port of the video-interface which is labeled as CAM.

Note: Picture settings for CAM input must be done in AV2.

2.6. Connecting video-interface and keypad

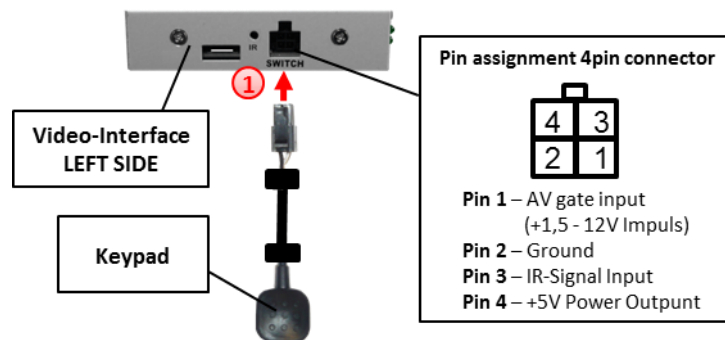

- ① Connect the female 4pin Microfit connector of the keypad to the male 4pin Microfit connector of the video-interface.

2.7. Picture Settings

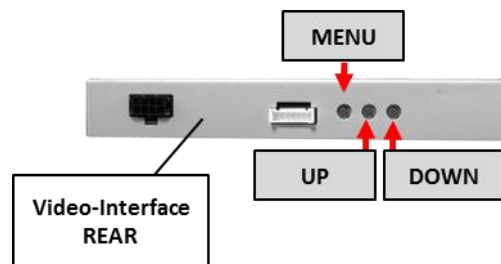

The picture settings are adjusted by the 3 buttons on the video-interface. Press the MENU button to open the OSD settings menu or to switch to the next menu item. Press UP and DOWN change the selected value. The buttons are embedded in the housing to avoid accidental changes during or after installation. Picture settings must be done separately for RGB, AV1 and AV2 while the corresponding input is selected and visible on the monitor. AV2 and CAM share the same settings which must be adjusted in AV2.

Note: The OSD menu is only shown when a working video source is connected to the selected video-input of the interface.

The following settings are available:

- Brightness
- Contrast
- Saturation
- Position H (horizontal)
- Position V (vertical)



3. Interface operation

3.1. By Comand-buttons

Some of the Comand-buttons can be used to execute interface functions.

Long pull back (3 sec.) **knob** in centre console to switch the video source. Each repetition will switch to the next enabled input. If all inputs are enabled the order is:

Factory video → RGB-in → video IN1 → video IN2 → factory video →...



Inputs which are not enabled are skipped. If the audio cable is connected, when switching from video IN1 to video IN2, also the sound will be switched.

When the interfaces video is activated, longpress of button “C” switches directly to the interfaces RGB-input.

Note: Alternatively the white cable of 6-Pin by means of a +5-12V impulse can be used for the switch of the video-sources.

3.2. By keypad

Alternatively or additionally to the factory infotainment buttons the interface’s keypad can be used to switch the enabled inputs.

4. Specifications

BATT/ACC range	7V ~ 25V
Stand-by power drain	<5mA
Power	0.3A @12V
Power consumption	4.8W
Video input	0.7V~1V
Video input formats	PAL/NTSC
RGB-Video amplitude	0.7V with 75 Ohm impedance
Temperaturr range	-40°C to +85°C
Weight	343g
Dimensions (box only) B x H x T	152 x 21 x 90 mm

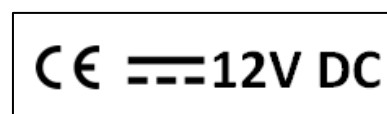

3. Frequently asked questions

For any troubles which may occur, check the following table for a solution before requesting support from your vendor.

Symptom	Reason	Possible solution
No picture/black picture (factory picture).	Not all connectors have been reconnected to factory head-unit or monitor after installation.	Connect missing connectors.
	No power on CAN-bus box (all LED CAN-bus box are off).	Check power supply of CAN-bus box. Check CAN-bus connection of CAN-bus box.
	CAN-bus box connected to CAN-bus in wrong place.	Refer to the manual where to connected to the CAN-bus. If not mentioned, try another place to connect to the CAN-bus.
	No power on video-interface (all LED video-interface are off).	Check whether CAN-bus box delivers +12V ACC on red wire output of 8pin to 6pin cable. If not cut wire and supply ACC +12V directly to video-interface.
No picture/black picture/white picture (inserted picture) but factory picture is OK.	No picture from video source.	Check on other monitor whether video source is OK.
	No video-source connected to the selected interface input.	Check settings dips 1 to 3 of video interface which inputs are activated and switch to corresponding input(s).
	LVDS cables plugged in wrong place.	Double-check whether order of LVDS cables is exactly connected according to manual. Plugging into head-unit does not work when the manual says to plug into monitor and vice versa.
Inserted picture totally wrong size or position.	Wrong monitor settings of video-interface.	Try different combinations of dips 7 and 8 of video-interface. Unplug 6pin power after each change.
Inserted picture double or 4 times on monitor.		
Inserted picture distorted, flickering or running vertically.	Video sources output set to AUTO or MULTI which causes a conflict with the interfaces auto detection.	Set video source output fixed to PAL or NTSC. It is best to set all video sources to the same standard.
	If error occurs only after source switching: Connected sources are not set to the same TV standard.	Set all video sources to the same standard.
	Some interfaces can only handle NTSC input.	Check manual whether there is a limitation to NTSC mentioned. If yes, set source fixed to NTSC output.
Inserted picture b/w.	Picture settings have not been adjusted.	Use the 3 buttons and the interface's OSD to adjust the picture settings for the corresponding video input.
Inserted picture qual. bad.		
Inserted picture size slightly wrong.		
Inserted picture position wrong.		
Camera input picture flickers.	Camera is being tested under fluorescent light which shines directly into the camera.	Test camera under natural light outside the garage.
Camera input picture is bluish.	Protection sticker not removed from camera lens.	Remove protection sticker.

Symptom	Reason	Possible solution
Camera input picture black.	Camera power taken directly from reverse gear lamp.	Use relay or electronics to "clean" reverse gear lamp power. Alternatively, if CAN-bus box is compatible with the vehicle, camera power can be taken from green wire of 6pin to 8pin cable.
Camera input picture has distortion.		
Camera input picture settings cannot be adjusted.	Camera input picture settings can only be adjusted in AV2 mode.	Set dip 3 of video-interface to ON (if not input AV2 is not already activated) and connect the camera to AV2. Switch to AV2 and adjust settings. Reconnect camera to camera input and deactivate AV2 if not used for other source.
Graphics of a car in camera input picture.	Function PDC is ON in the interface OSD.	In compatible vehicles, the graphics will display the factory PDC distance. If not working or not wanted, set interface OSD menu item UI-CNTRL to ALLOFF.
Chinese signs in camera input picture	Function RET or ALL is ON (function for Asian market) in the interface OSD.	Set interface OSD menu item UI-CNTRL to ALLOFF or PDCON.
Not possible to switch video sources by OEM button.	CAN-bus interface does not support this function for vehicle.	Use external keypad or cut white wire of 6pin to 8pin cable and apply +12V impulses for AV-switching.
Not possible to switch video sources by external keypad.	Pressed too short.	For video source switching a longer press of about 2.5 seconds is required.
	SW-version of interface does not support external keypad.	Use OEM-button or cut white wire of 6pin to 8pin cable and apply +12V impulses for AV-switching.
Interface does not switch to camera input when reverse gear is engaged.	CAN-bus interface does not support this function for the vehicles.	Cut the green wire of the 6pin to 8pin cable and apply +12V constant from reverse gear-lamp signal. Use relay to "clean" gear lamp power.
Interface switches video-sources by itself.	CAN-bus interface compatibility to vehicle is limited.	Cut the grey wire of 6pin to 8pin and isolate both ends. If problem still occurs, additionally cut the white wire of 6pin to 8pin cable and isolate both ends.

4. Technical Support

Please note that direct technical support is only available for products purchased directly from NavLinkz GmbH. For products bought from other sources, contact your vendor for technical support.

NavLinkz GmbH
distribution/tech dealer-support
 Eurotec-Ring 39
 D-47445 Moers

Tel +49 2841 949970
 Email mail@navlinkz.de

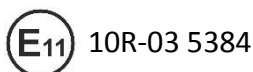

Made in China

