

## PARKING SENSOR FOR FRONT AND REAR APPLICATIONS

### OPERATING PRINCIPLE

---

The product is an electronic device conceived to park the vehicle easier.

This system has been designed for application on the front or rear bumper of the vehicle.

The front system requires the push button (Y) supplied in the kit, to be connected to the slot 3 of the control unit (general diagram on page 13).

The parking sensor is based on the principle of the sound wave reflection when an obstacle is detected.

Knowing the speed at which sound propagates in the air and measuring the time that elapses between the emission of a sequence of pulses and its reception, after it has been reflected by an obstacle, it is then possible to calculate the distance of the obstacle itself from the sound energy source (sensor).

For this purpose, there are 4 sensors allowing to completely protect the vehicle's surfaces.

Each sensor consists of an ultrasounds capsule that also acts as a receiving element of the reflected wave.

An intermittent beep warns about the approaching of the vehicle to an obstacle.











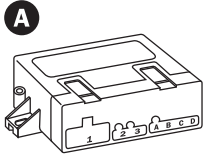



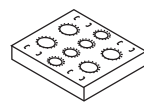



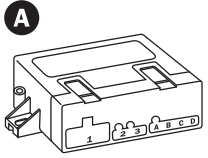



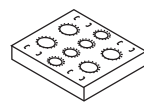





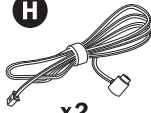

The nearer the car gets to the obstacle the faster the beeping becomes, until turning into a continuous sound when the minimum safety distance is reached.

### INDEX

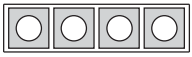
---

Kit contents .....	Pag. 12
Installation tools .....	Pag. 12
General wiring diagram .....	Pag. 13
Technical features .....	Pag.13
Painting the capsules and the relevant supports .....	Pag. 13
General recommendations before starting the installation .....	Pag. 14
Sensors fixing positions .....	Pag. 14
- Installation with the ISH system (Internal Sensor Holder) .....	Pag. 15
- Installation with the ESH system (External Sensor Holder) .....	Pag. 16
Programming .....	Pag. 17
Masking procedure .....	Pag. 17
Reducing the system's performance .....	Pag. 18
Reducing the side sensors detection .....	Pag. 18
System modes for the front application .....	Pag. 18
Recording the speed threshold .....	Pag. 18
Calibration.....	Pag.19
Additional functions .....	Pag.19
- Car stereo mute (for front and rear systems, activated through the push button) .....	Pag. 19
System's cut-off for trailer connection to the vehicle .....	Pag. 19
Diagnostics.....	Pag.20
How to use the front system .....	Pag. 20
How to use the rear system .....	Pag. 20

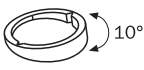
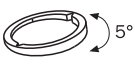
## KIT CONTENTS

 <b>A</b>  <b>B</b>  <b>C</b>  <b>D</b>  <b>E</b>  <b>F1</b>  <b>F2</b>  <b>O1</b>  <b>O2</b>	 <b>x1</b>	 <b>x1</b>	 <b>x2</b>	 <b>x1</b>	 <b>x1</b>	 <b>x4</b>	 <b>x4</b>	 <b>x4</b>	 <b>x4</b>					
 <b>G</b> <b>x2</b> 4,2 MT. Yellow/Light blue (X - Y)	 <b>H</b> <b>x2</b> 3,5 MT. Black/White (Z - K)	 <b>I</b> <b>x1</b>	 <b>L</b> <b>x1</b>	 <b>M</b> <b>x4</b>	 <b>N</b> <b>x1</b>	 <b>P1</b> <b>x1</b>	 <b>P2</b> <b>x1</b>							
<b>OPT: ABP05580</b> <b>Front installation accessory</b>  <b>Y</b> <b>x10</b>				<b>OPT: ABP0214 - ESH installation accessories</b>  <b>Q</b> <b>x4</b>						 <b>R</b> <b>x4</b>	 <b>S</b> <b>x4</b>	 <b>T</b> <b>x4</b>	 <b>U</b> <b>x4</b>	 <b>V</b> <b>x4</b>

## LEGEND

### The Kit Includes

A - Control Unit  
 B - Screwdriver for calibration  
 C - Adhesive velcro  
 D - Loudspeaker  
 E - Painting template  
 F - Silicone ring  
 G - 4,2 M. sensor's wire harness  
 H - 3,5 M. sensor's wire harness  
 I - Loudspeaker's wire harness  
 L - Main ECU's wire harness  
 M - Capsules  
 N - Drilling templates

### ISH installation accessories

O - Sensors holders  
 P - Adhesive supports







### ESH installation accessories

Q - Silicone ring for spring  
 R - Spring  
 S - 10° slanting device  
 T - 5° slanting device  
 U - Ring nut  
 V - Spring stopper

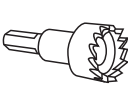
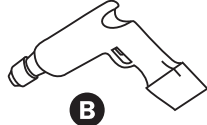
### Front installation accessory

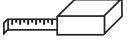
Y - ON-OFF Push button/LED for front application the front parking sensors

## INSTALLATION TOOLS

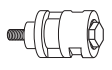
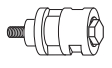
 <b>A</b>	 <b>B</b>	 <b>C</b>	 <b>D</b>	 <b>E</b>	 <b>F</b>	 <b>G</b>	 <b>H</b>	 <b>I</b>	 <b>L</b>
---	---	---	---	---	--	---	---	---	---

## LEGEND

A - Ø19 mm hollow cutter  
 B - Drilling machine  
 C - Ø2,5 mm drill  
 D - Roll-up measuring tape

E - Pliers  
 F - Cutter  
 G - Small round file

# GENERAL WIRING DIAGRAM

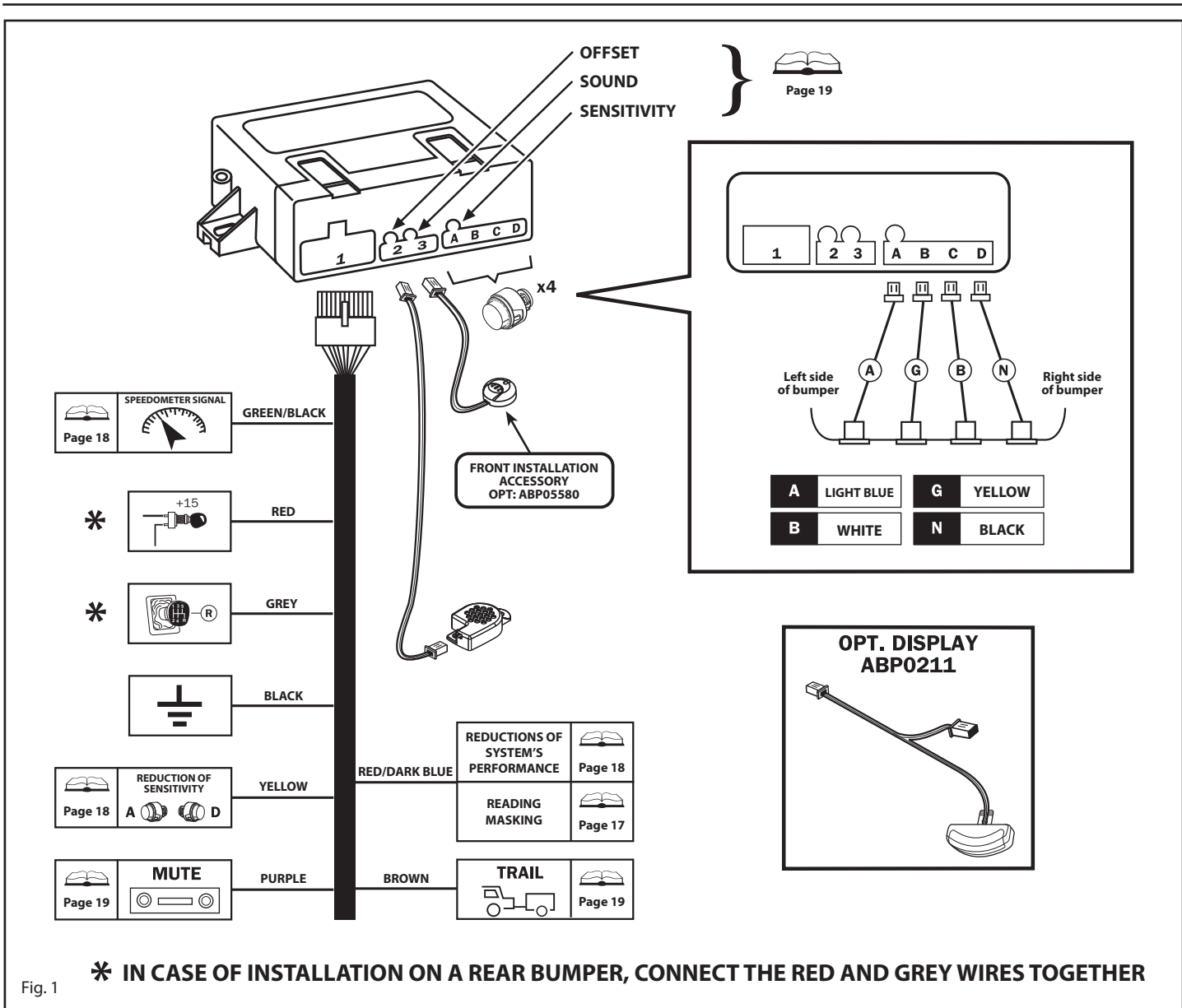

## TECHNICAL FEATURES

Power .....12Vcc (10V-15V)  
 Current absorption with the system active .....< 50mA

## PAINTING THE CAPSULES AND THE RELEVANT SUPPORTS

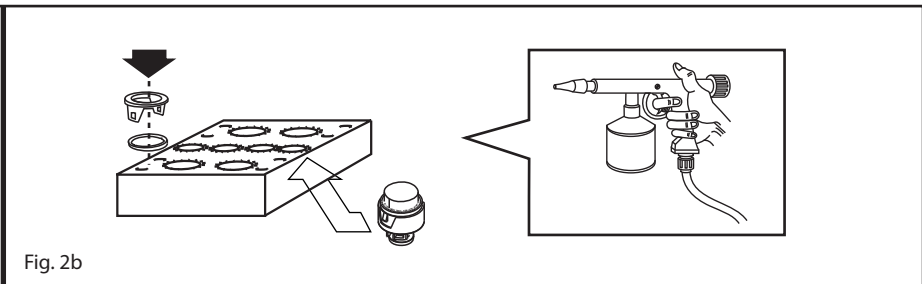
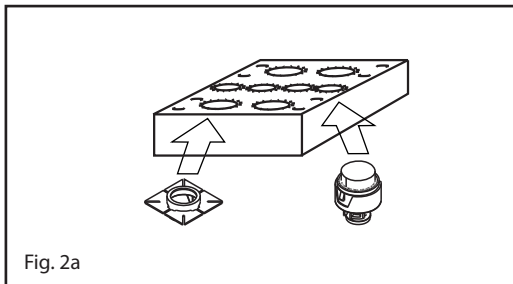

Before assembling the components of the sensors it is advisable to paint the capsules and supports in the same colour of the car. Use the carton mask, included into the kit, for painting in order to prevent paint from getting on parts of the capsule which would alter its performance. Specific primers must be applied first before painting; make sure the paint is completely dry before assembling the components.

## GENERAL RECOMMENDATIONS BEFORE STARTING THE INSTALLATION

The performance and accuracy of the system are strongly influenced by the position and orientation of the sensors. For this reason certain conditions have to be checked before starting the installation:

- On the positions chosen to place the sensors the bumper must provide enough depth internally and room for assembly without any forcing.
- Follow the positioning instructions and the tips on the accessories to be used, depending on the height and shape of the bumper.

It is extremely important to fit the sensors on the bumper and keeping a height that can vary from a maximum of about 65 cm to a minimum of 35 cm. It is important that the sensors are as vertical as possible from the ground.

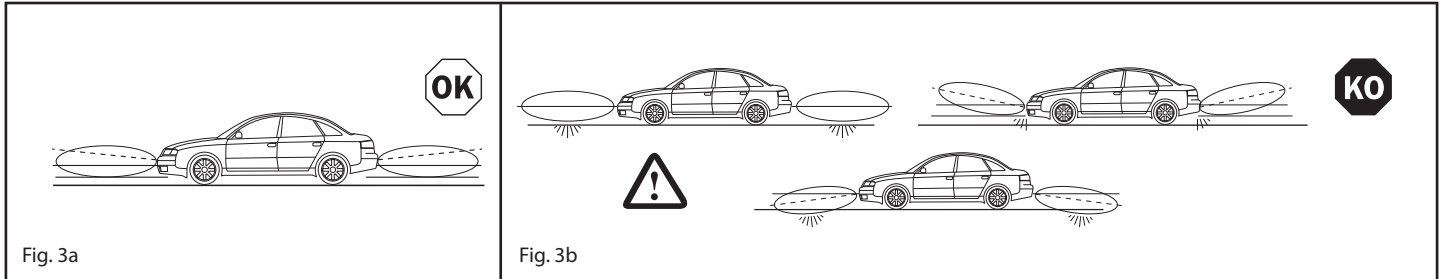

For this reason two types of spacer are part of the optional ESH pack (ABP0214): one has 5° inclination **A** and one a 10° inclination **B** (see installation with ring nut accessories **S** and **T**); they are indispensable to realign any incorrect inclination of the sensor, due to the shape of the bumpers. If, even with both spacers, it is impossible to get a vertical position, then it is preferable to use the one that allows to reach the highest position. If the bumper allows for a vertical position, the capsule fixing ring nut can be used without any spacer and in these conditions it is also possible to use the ISH system (see installation with ISH fig.5a and fig.5b).

## SENSORS FIXING POSITIONS

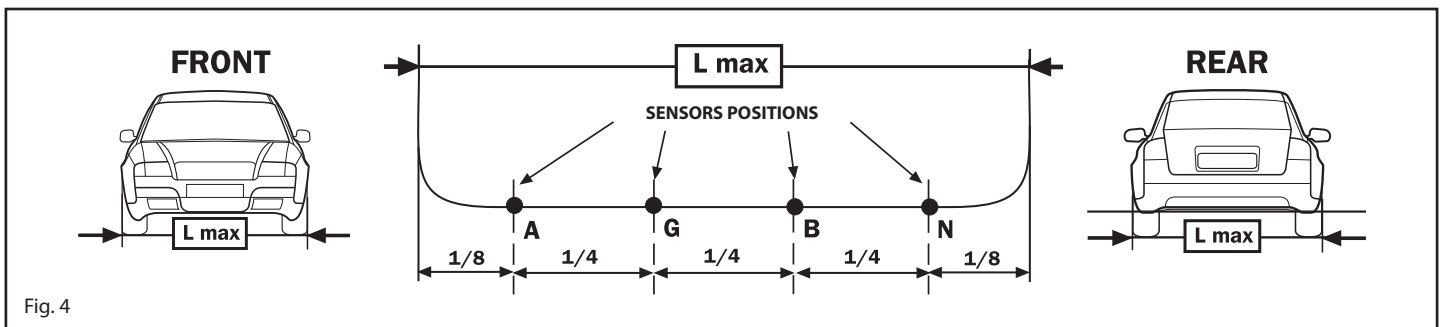

The distance between the sensors can vary from a minimum of 30 cm to a maximum of 70 cm. The important thing is that there must be the same distance between them all, likewise the external distances (as much as possible). If feasible it is advisable to position them as shown in the figure. When evaluating the position of the capsules it is important to consider their range of action:

**FRONT** { internal: 110 cm approx.  
external: 90 cm approx.

**REAR** { internal: 150 cm approx.  
external: 100 cm approx.

# INSTALLATION WITH THE ISH SYSTEM (WITHOUT INTERNAL SENSOR HOLDER)

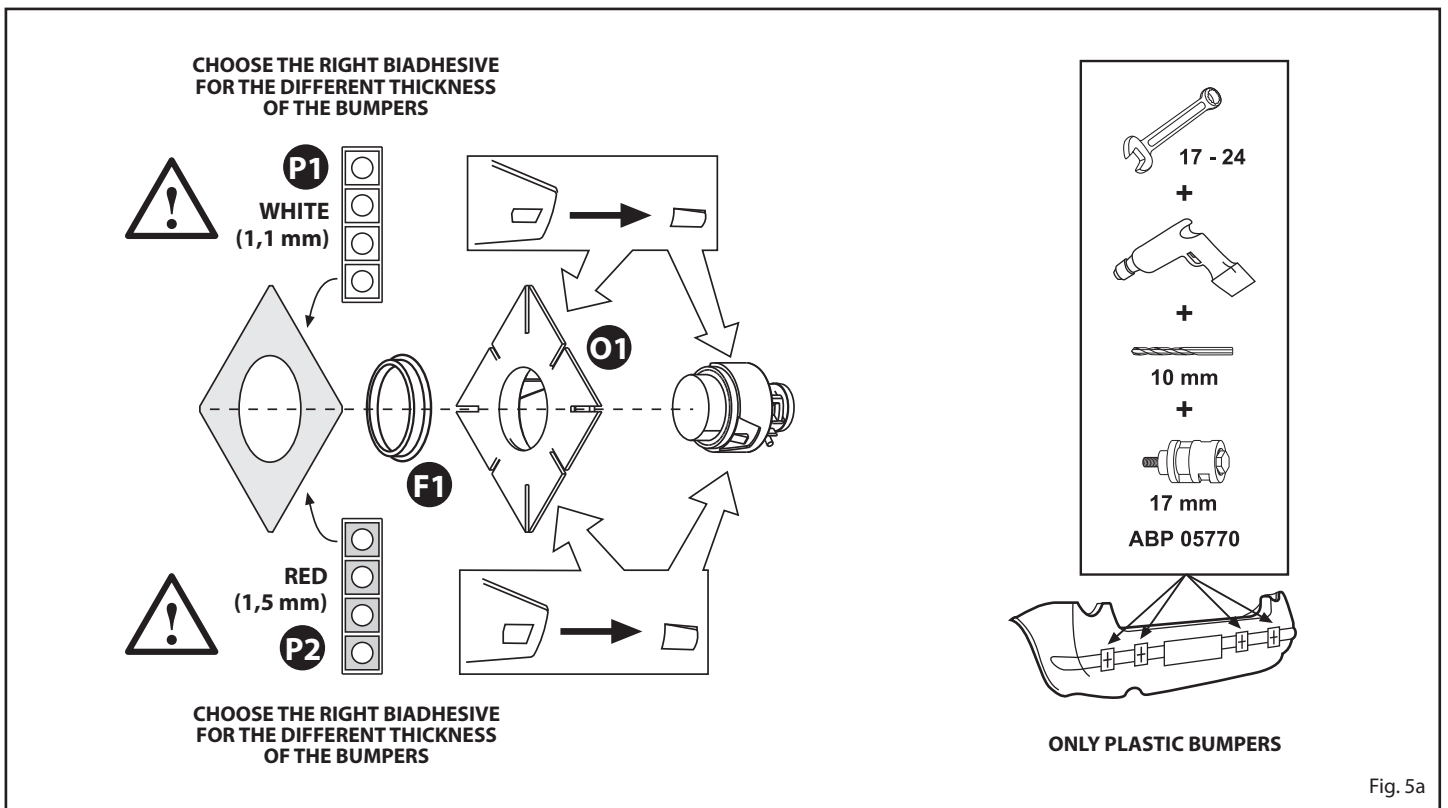

**NOTE: DRILL THE BUMPER FROM THE OUTSIDE**

# INSTALLATION WITH THE ISH SYSTEM (WITH INTERNAL SENSOR HOLDER)

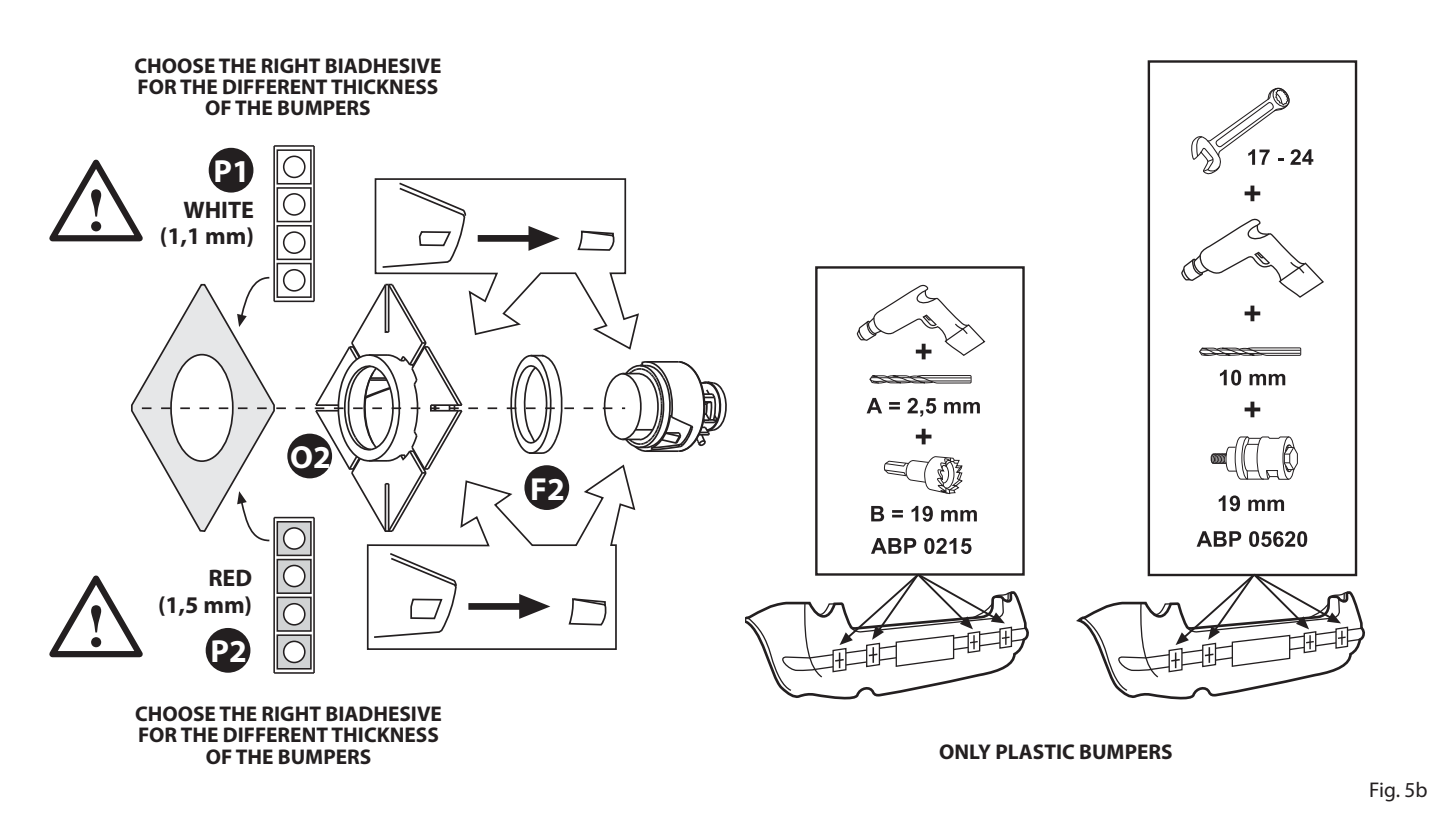

**NOTE: DRILL THE BUMPER FROM THE OUTSIDE**

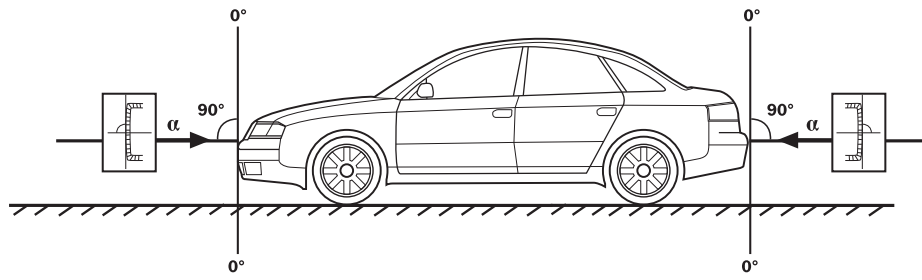
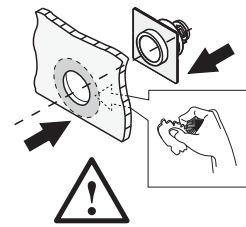
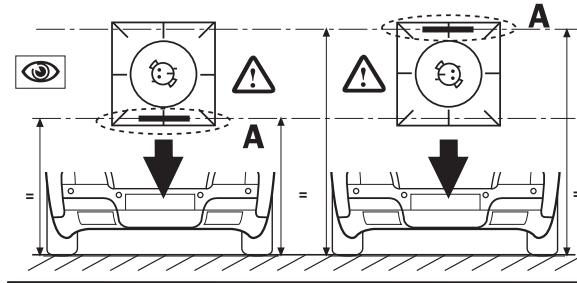
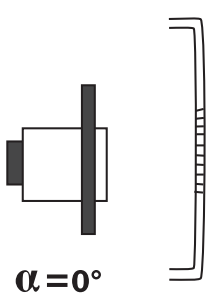

Fig. 6



**NOTE: DEGREASE THOROUGHLY BEFORE APPLYING THE TWO-SIDE ADHESIVE TAPE**



**NOTE: TO MAKE SURE OF A CORRECT WORKING, CHECK THAT THE POSITIONING REFERENCE ITEM (A) IS HORIZONTAL. ONCE THE SENSORS ARE FITTED TO THE BUMPER DO NOT WET OR FORCE THEM FOR THE NEXT 8 HOURS.**

### INSTALLATION WITH THE ESH SYSTEM (EXTERNAL SENSOR HOLDER)

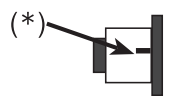
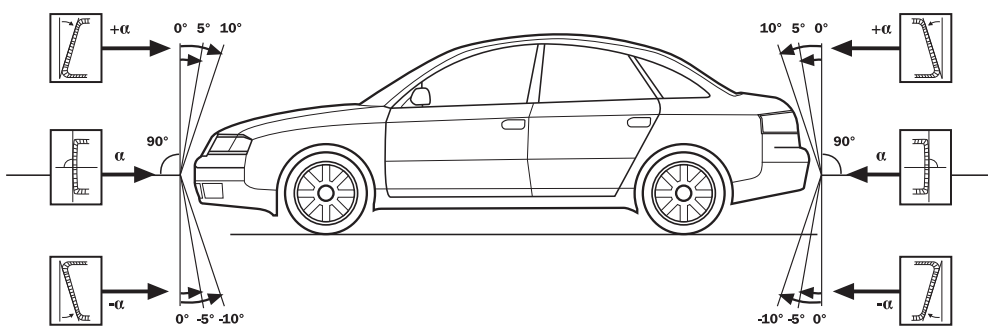
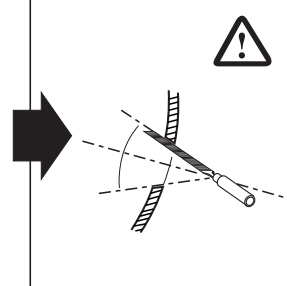
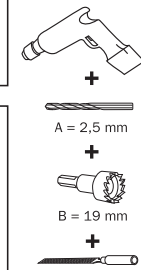
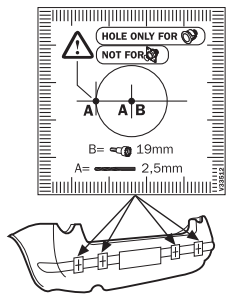
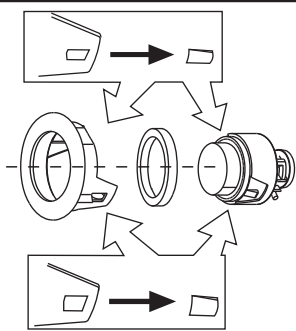

**NOTE: TO MAKE SURE OF A CORRECT WORKING CHECK THAT THE POSITIONING DOWEL (\*) IS FACING SIDWAYS**

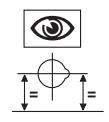
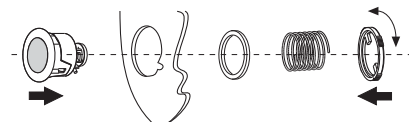
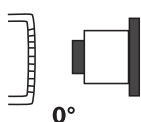
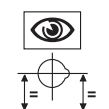
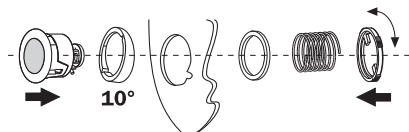
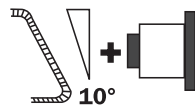
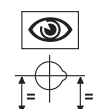
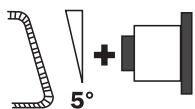
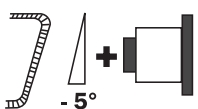

Fig. 7

## PROGRAMMING

There are two essential functions that ensure the correct working of the product on the vehicle: the speed programming (only for the front system) and the obstacles masking. The first sets the speed threshold that automatically enables/disables the parking system. The second one allows to make the parking system consider all fixed obstacles (e.g. tow bar) as part of the vehicle and thus it does not detect them during the parking manoeuvre. If, however, the installation is different to what specified, the system can still perform two additional settings: one to reduce performance (to be used only if strictly necessary) and another one that allows to reduce the detection range of the side capsules (only for very round bumpers or when the position of the side capsules is very close to the edges of the car). Here are the procedures to apply the 4 settings:

- **MASKING THE DETECTION OF OBSTACLES OR JUTTING PARTS**
- **REDUCING SYSTEM PERFORMANCE**
- **REDUCING SIDE CAPSULE READING**
- **RECORDING SPEED (if system used with odometer)**

### MASKING PROCEDURE

The system can exclude fixed objects, such as the tow hook or spare wheel (in case of rear application) or protruding parts (front application) that are always inside the detection area of the sensors and ensure that they will no longer be detected during each parking manoeuvre. To programme follow these steps:

**NOTE: make sure that no objects are around the vehicle. Keep at least 1 m of clearance from any object before launching this procedure.**

1. Unplug the PUSH BUTTON/LED connector from the front control unit, position 3 (see scheme at page 13 - Fig.1).
2. Connect temporarily the RED/BLUE wire to negative (GND) with the system off.
3. Connect the RED and GREY wire to +12V, the control unit generates 1 acute beep. After a maximum of 120 sec., another 2 beeps are emitted if programming was successful or 4 beeps in case of failure.
4. Disconnect the RED and GREY wire from +12V and disconnect the RED/BLUE wire from the negative.
5. Re-plug the PUSH BUTTON/LED connector and then test the system.

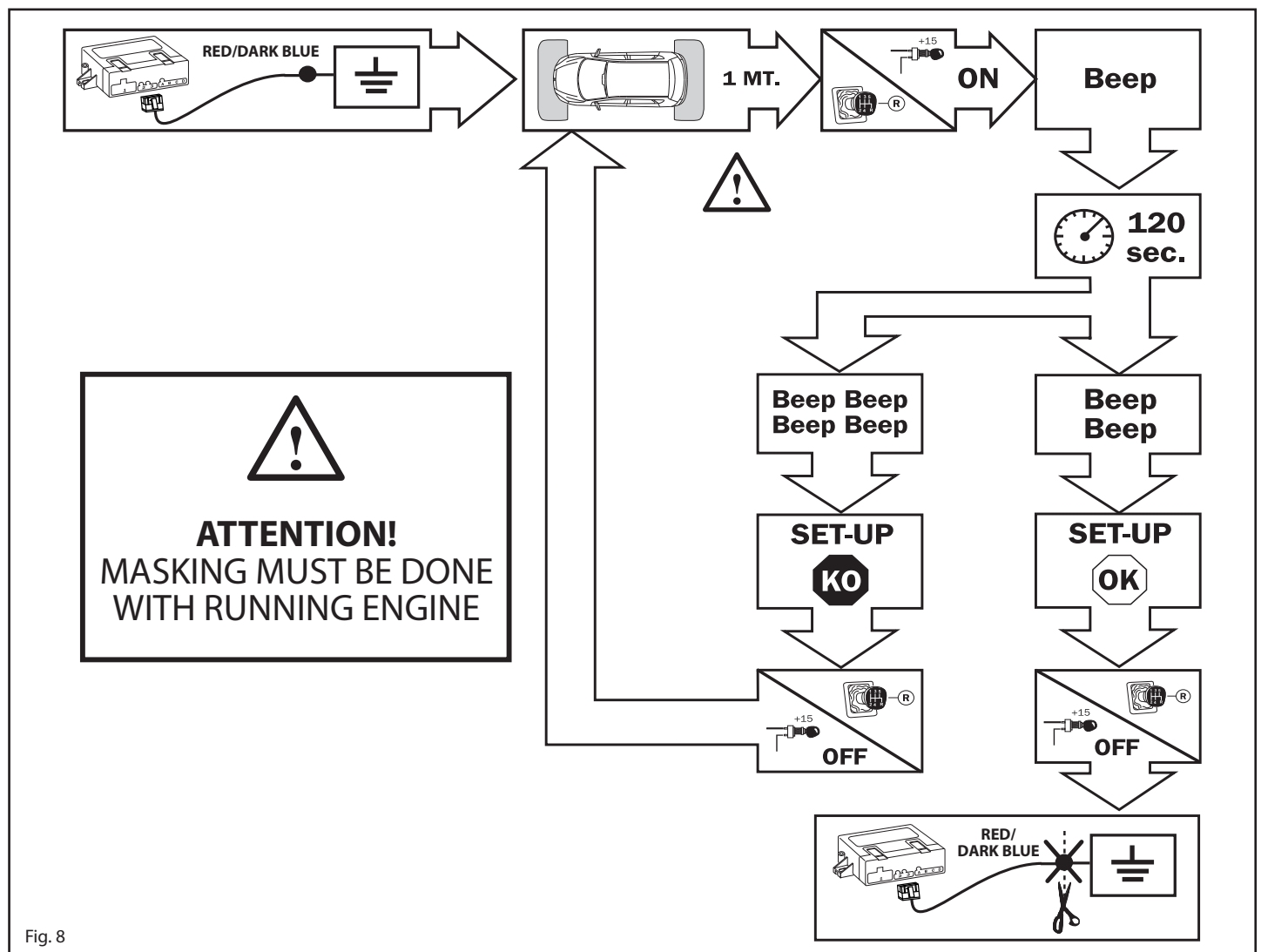

Fig. 8



**NOTE:** IN THE MAJORITY OF CASES TO LAUNCH THE MASKING PROCESS IT IS SUFFICIENT, AFTER CONNECTING THE RED/BLUE WIRE TO THE NEGATIVE, TO TURN THE IGNITION ON (+15 V) WITH THE REVERSE GEAR ENGAGED. HOWEVER PAY ATTENTION TO CARS WHERE THE REVERSE GEAR IS ACTIVATED WITH A DIFFERENT TIMING FROM IGNITION IN THIS CASE, IT IS NECESSARY TO CONNECT THE RED AND GREY WIRES TO +12V.

## REDUCING THE SYSTEM'S PERFORMANCE

This function is to be used only if strictly necessary. It drastically cuts system performance which prevents false detections, in case the product is installed differently from what prescribed in this document. To set this function, simply connect the RED/BLUE wire to the reverse gear positive.

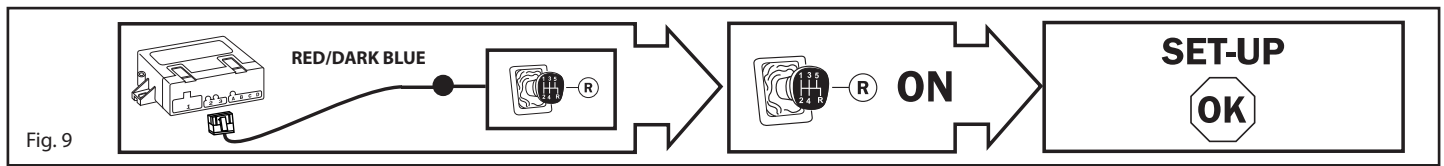

## REDUCING THE SIDE SENSORS DETECTION

The range of detection of the side capsules can be reduced in case it wouldn't allow the driver correctly evaluate the distance from an obstacle, during a tricky parking manoeuvre. To activate this function, simply connect the YELLOW wire to the negative (GND). This function is recommended in the majority of the applications.

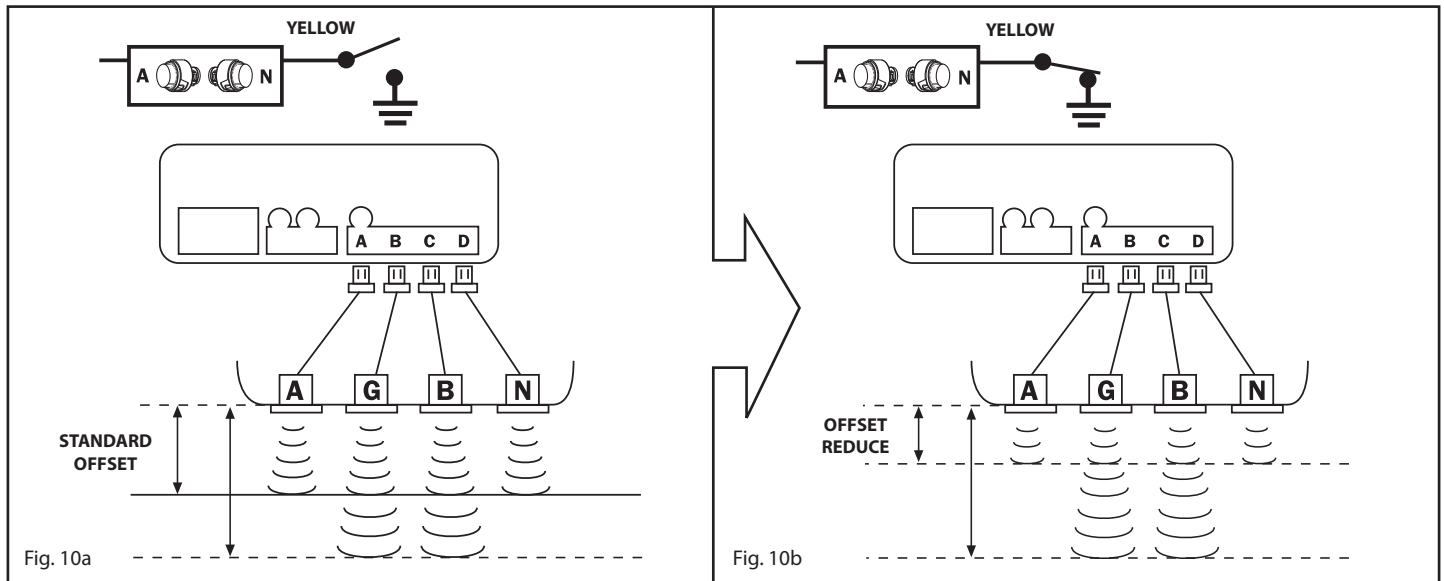

## SYSTEM MODES FOR THE FRONT APPLICATION

The parking system for a front bumper application can be used in 3 different ways, depending on how it is set-up via the PDC/Alarm programmer; two of these modes entail recording the speed measured by connecting the GREEN/BLACK wire to the vehicle's odometer. **With all 3 modes, the front parking system activates as soon as the ignition is turned ON and/or the reverse gear is engaged.** The differences between these functional modes are:

### 1) Manual system (factory setting):

The system switches off 20 seconds after having disengaged the reverse gear or, alternatively, by pressing the push button/LED, even with the reverse gear engaged. The system can be reactivated by selecting again the reverse gear or pressing the push button /LED.

### 2) System switching off according to the speed (set-up via PDC programmer of function 43 ON):

The system switches off a few seconds after having exceeded the speed Programmed and reactivates again after having engaged the reverse gear or pressed the push button/LED, if the vehicle's speed is under the programmed threshold.

### 3) Switching off and activation on speed (programming with the PDC programmer of functions 43 and 44 ON):

This setting is not connected to the reverse gear. The parking system activates the very moment the instrument panel is turned on and deactivates a few seconds after having overtaken the programmed speed.

The system automatically reactivates by slowing down the vehicle, under the programmed speed threshold.

**TEMPORARY DISENGAGEMENT:** In order to temporarily exclude the automatic system reactivation, press the push button/LED. The system will resume all its functions by pressing again the push button/LED or automatically the next time the ignition is turned on.

## RECORDING THE SPEED THRESHOLD

Follow the procedure described below to adjust the system's deactivation speed threshold:

1. Start the engine and check that the push button/LED is on.
2. Press the push button/LED once and check that it turns off.
3. Press the push button/LED and hold it down for about 30 seconds. Wait until a series of beeps (6) is generated to advise that the system has entered the speed threshold adjusting mode.
4. Keep driving the vehicle (it is advisable not to overtake 30Km/h). When the chosen speed is reached, press the push button/LED to have it recorded.

To check if the system has recorded the right speed value, exceed this speed and check that, after a few seconds, the system turns itself off (push button/LED OFF); then slow down under the speed threshold and check that a few seconds later the system turns back on (push button/LED ON).



## CALIBRATION

With the three trimmers on the front of the control unit it is possible to finely tune the system's performance on the basis of the customer's requirements or on the shape of the bumper. The trimmers manage the three following functions:

**SENSITIVITY** - Adjusting the capsules' reading sensitivity. Therefore it is possible to modify the protection space.

**OFFSET** - Danger zone "continuous sound" detection distance.

**VOLUME** - To manage the loudspeaker's volume.

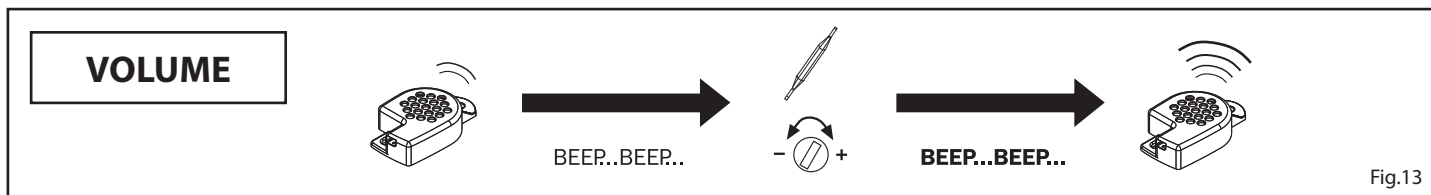
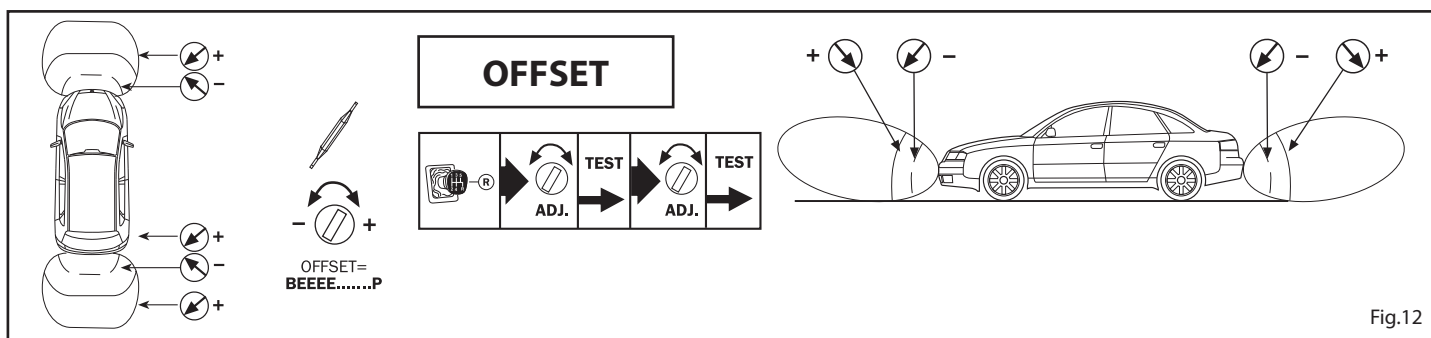
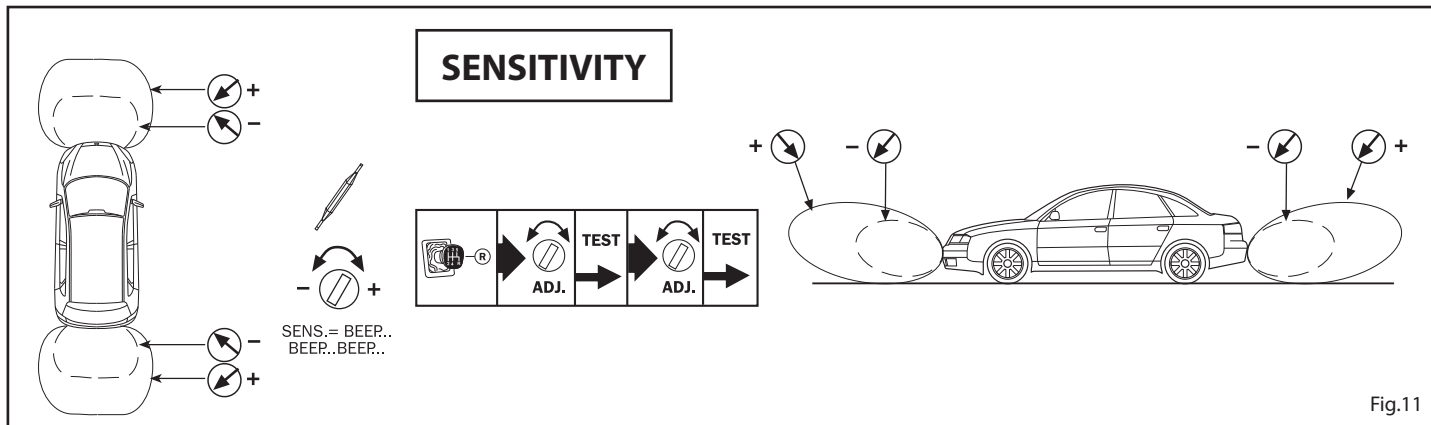

## ADDITIONAL FUNCTIONS

**CAR STEREO MUTE** - This function allows to automatically mute the car stereo during a parking manoeuvre and, more generally, at the very activation of the parking system to prevent the sound of the stereo from covering the signalling of a possible obstacle.

To activate this function, connect the PURPLE wire to the car stereo MUTE setting.

*NOTE FOR FRONT APPLICATION: If the parking system is programmed to work with the vehicle's odometer, it is advisable NOT to use the mute function.*

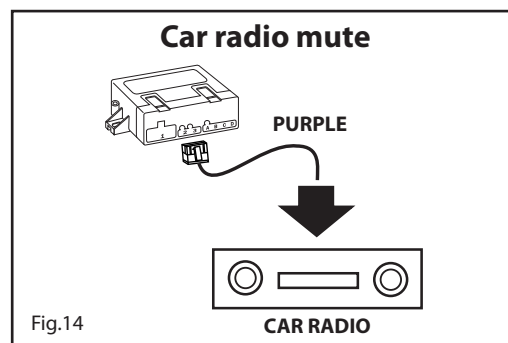

## SYSTEM'S CUT-OFF FOR TRAILER CONNECTION TO THE VEHICLE

**TRAILER** - this rear application dedicated function allows to automatically deactivate the control unit when the ground line has been taken from the trailer's electric connector.

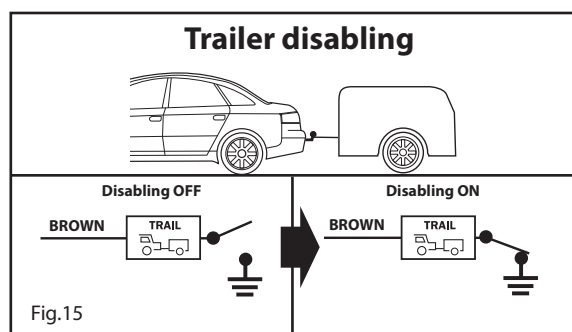

## DIAGNOSTICS

While the system is working it constantly keeps a self-diagnosis operation running in order to warn the user - through specific acoustic signals - if one or more sensors are not correctly working. If failures occur, one or more acoustic signals are generated at every activation:

- **long beep with different tone + N° 1 short beep = Sensor A fault;**
- **long beep with different tone + N°2 short beeps = Sensor G fault;**
- **long beep with different tone + N° 3 short beeps = Sensor B fault;**
- **long beep with different tone + N°4 short beeps = Sensor N fault;**

After the system has provided the above mentioned information, it cuts-off the faulty sensors and then starts working as usual. If the failure occurs during a parking manoeuvre, the control unit stops its standard detection/signalling of an obstacle and generates the diagnostic signal described above.

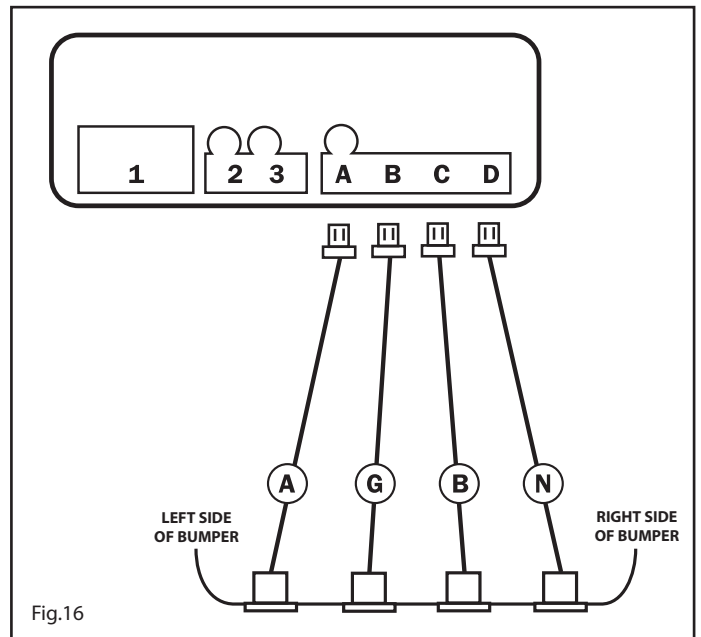

## HOW TO USE THE FRONT SYSTEM

The acoustic signal is intermittent when an obstacle is detected, and grows in frequency as the vehicle gets closer to the obstacle itself, starting from around 110 cm, it becomes a continuous sound when the car is at about 30 cm to it (Fig. 17).

Signalling frequency decreases down to about 80-90 cm when moving away from the obstacle and it stops if the vehicle moves further away from the obstacle itself.

The system automatically activates when the ignition is switched on and when reverse gear is engaged whereas turning off depends on what was programmed during the installation; the following 3 modes are possible:

### 1) System with timer or manual:

The system deactivates 20 seconds after the reverse gear has been deselected and reactivates each time the reverse gear is engaged or the push button/LED is pressed.

### 2) System's cut-off for overtaking the speed threshold:

The system deactivates when the programmed speed is overtaken and reactivates each time the reverse gear is selected or the push button/LED is pressed.

### 3) System's switch-off for overtaking the speed threshold and automatic reactivation as speed slows down within the limit:

The system deactivates when the programmed speed is overtaken and reactivates each time the vehicle slows down the same speed threshold, allowing to constantly protect the car during the low speed manoeuvres.

The system can be disabled with the push button/LED until the next time the ignition has started or by pressing the push button/LED.

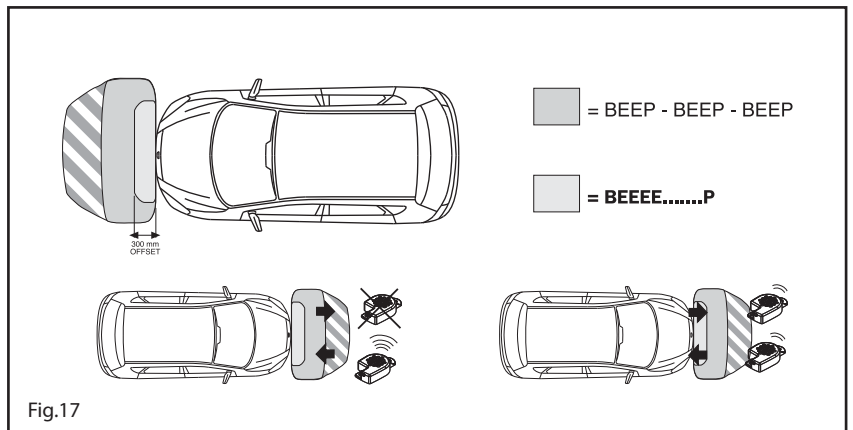

## HOW TO USE THE REAR SYSTEM

When reverse gear is engaged, one BEEP signals the system's activation.

The acoustic signal is intermittent when an obstacle is detected, and grows in frequency as the vehicle gets closer to the obstacle itself, starting from around 150 cm, it becomes a continuous sound when the car is at about 30 cm to it (Fig. 18). Signalling frequency decreases down to about 80-90 cm when moving away from the obstacle and it stops if the vehicle moves further away from the obstacle itself.

