



### What's in the Box

#### Dallas Face



#### Shafts

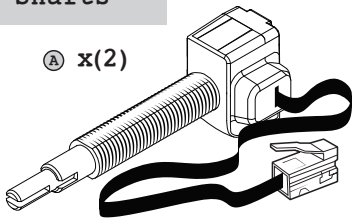

#### Brackets

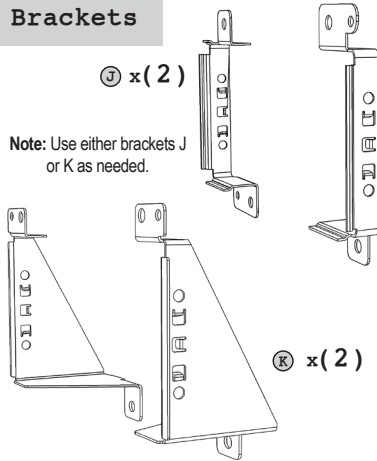

#### Adapters

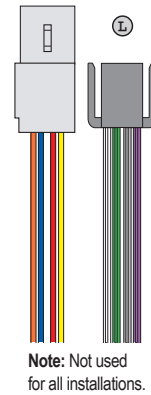

#### Knobs

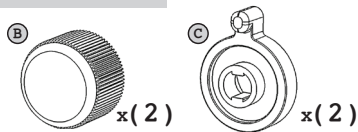

#### Hardware

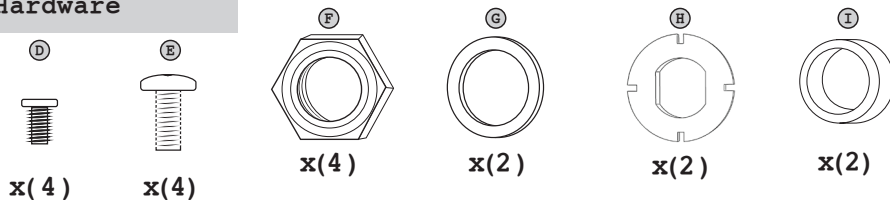

### Installation

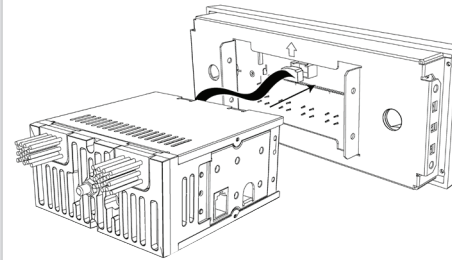

Plug the ribbon cable from the Radio Motor into the Radio Face.

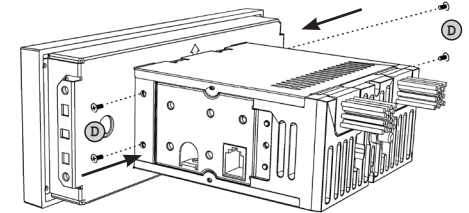

Attach the Radio Face to the Radio Motor using the four small screws from the orange bag found in your Radio Face box.

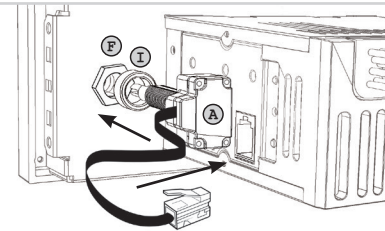

Place a small metal spacer on each control shaft and secure with a shaft nut. Slide the shafts through the Radio Face with the shaft's cord facing out. Plug the control shafts into the Radio Motor.

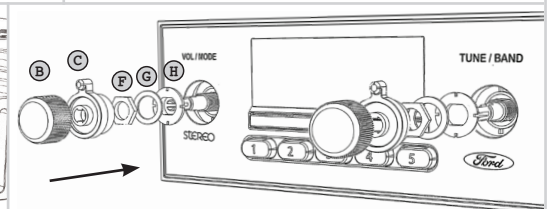

Place the small black plastic washer and the thin metal washer onto the shaft, and secure with the shaft nut using a deep-well socket. DO NOT OVERTIGHTEN. Finish the assembly by installing the front and rear knobs.

Install the mounting brackets with the radio facing you. Attach the bracket labeled R to the right side and the bracket labeled L to the left side. Line up tabs and use supplied screws to secure the brackets to the Radio Face.

To use the optional wiring adapters(L) (if the vehicle has a compatible factory harness intact), plug the adapters into the factory wiring harness and match the wiring color to the color on the adapter that came with the Radio Motor. Not all wires may be needed, cap off any unused wires that do not match the factory harness.

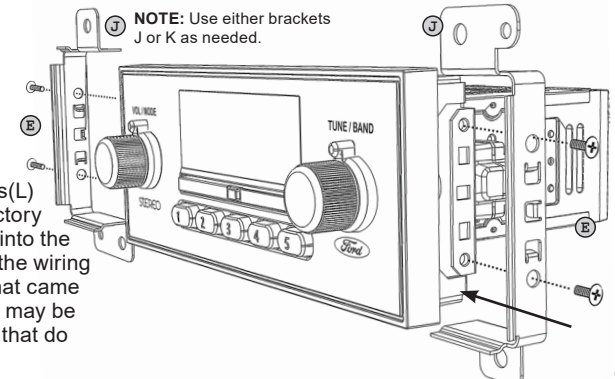

Refer to the user manual included in your motor box or on our website for more comprehensive instructions.

### Control Layout

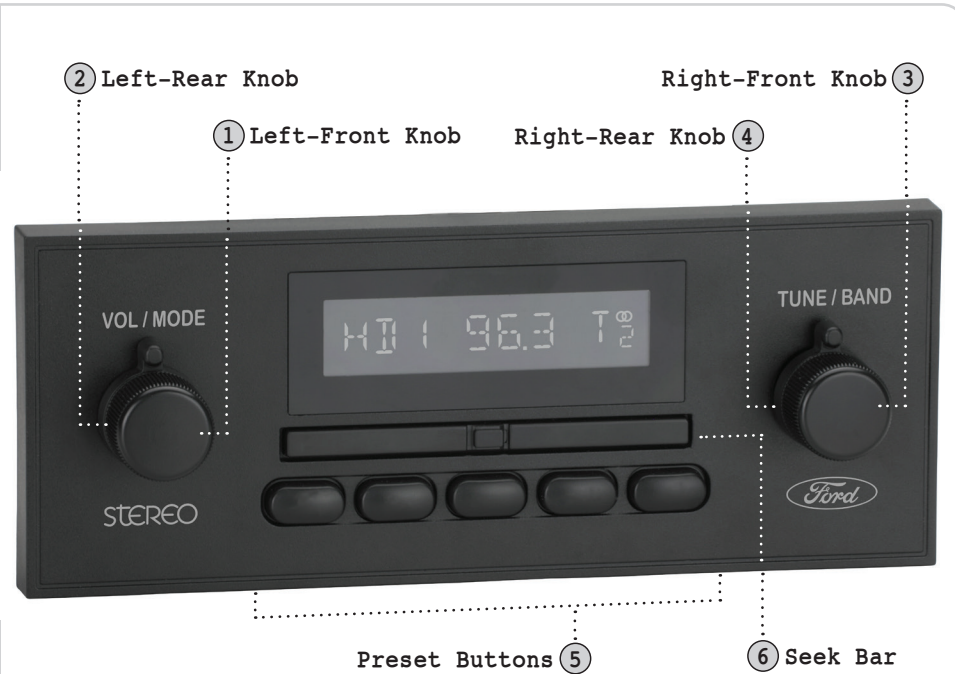

### Radio Presets

#### Setting Radio Presets

To set a preset, tune to the station you want to set the preset to, and then press and hold the desired Preset Button(5) for two seconds.

#### Recalling Radio Presets

To recall a preset, simply press the Preset Button(5) your station was set to previously.

### Basic Operation

#### Power On/Off

Press the Left-Front Knob(1) to power the unit on.  
Press and hold the Left-Front Knob(1) to power the unit off.

#### Volume

Rotate the Left-Front Knob(1) to change the volume.

#### Changing Source Modes

Rotate the Left-Rear Knob(2) clockwise to cycle through the source modes.

#### Changing Radio Bands

Rotate the Right-Rear Knob(4) counter-clockwise to cycle through the radio bands.

#### Tune

Rotate the Right-Front Knob(3) to scroll through the stations.

#### Seek Bar

Press the Seek Bar(6) to find the previous/next station, or skip to the previous/next track.

#### Mute On/Off

Press the Right-Front Knob(3) to mute and unmute.

#### Equalizer (EQ)

Press the Left-Front Knob(1) to enter the Tone Control sub-menu. Press and release the Left-Front Knob(1) until you see the EQ setting you'd like to adjust. Rotate the Left-Front Knob(1) to adjust the setting. Press the Left-Front Knob(1) to move to the next item, and repeat to adjust each option. Let the unit time out to set.

#### Setting the Clock

Press and hold the Right-Front Knob(3) to enter the System Settings sub-menu. Rotate the Right-Front Knob(3) to cycle through the choices until you see CLK, then press the Right-Front Knob(3) to select. Rotate the Right-Front Knob(3) to adjust the hours. Then press the Right-Front Knob(3) again to move on to minutes. Rotate the Right-Front Knob(3) to adjust the minutes. Let the unit time out to set.

#### Display Color\*

Press and hold the Right-Front Knob(3) to enter the System Settings sub-menu. Rotate the Right-Front Knob(3) to cycle through the choices until you see SCAN, then press the Right-Front Knob(3) to cycle through the colors. Let the unit time out to set.

#### Beep On/Off

Press and hold the Right-Front Knob(3) to enter the System Settings sub-menu. Rotate the Right-Front Knob(3) to cycle through the choices until you see BEEP ON/OFF, then press the Right-Front Knob(3) to choose between BEEP ON or BEEP OFF. Let the unit time out to set.

\*Some features are not available on all radios.